

ON THE CLASSIFICATION  
OF NON-REALIZABLE ORIENTED MATROIDS

Jürgen Bokowski  
Jürgen Richter-Gebert

Preprint Nr. 1345

Dezember 1990

**ON THE CLASSIFICATION  
OF NON-REALIZABLE ORIENTED MATROIDS  
Part II. Properties**

Jürgen Bokowski and Jürgen Richter-Gebert

**Abstract**

*The enumeration of all reorientation classes of oriented matroids with 8 points in rank 4 was described in Part I. This article is devoted to properties of the non-linear cases. We analyse their final polynomials, we classify the euclidean examples, and we provide a partial answer to the connectivity question of the mutation graph of Cordovil and Las Vergnas.*

**1. Non-linear oriented matroids in rank 4 with 8 points**

A main problem in oriented matroid theory is finding out whether or not properties of point configurations in a vectorspace over a field  $K$  carry over to the oriented matroid setting. There is a need for small non-linear examples or counter-examples for this purpose. For oriented matroids in rank 4 with 8 points, the minimal case of interest, only a few non-linear examples were known. A reorientation class with 7 mutations was studied by Roudneff [19] when he investigated pseudo-line arrangements. The same example turned out to be the essential underlying structure in the proof that a certain combinatorial sphere is not polytopal, i.e. the sphere cannot occur as the face-lattice of a convex polytope, [4]. Another example was studied in oriented matroid programming by Fukuda and Mandel, see [11], see also the presentation in Ziegler [24]. Here the non-degenerate cycling in general oriented matroid programming was described by using essentially this particular example. Among known examples we find also in Bland and Las Vergnas, [3] p. 110, the orientable Vamos matroid. Moreover, Goodman and Pollack in [13] presented a non-uniform non-linear example showing that Levi's enlargement lemma does not carry over to higher rank. In all these cases, there was no general method of generating the examples of interest. Intuition seemed to be the only way. After our classification of all these and other new examples, the whole set of examples and counter-examples can be seen in a general framework.

The emphasize of this article is on the study of these non-linear reorientation classes, i.e. the study of the combinatorial abstraction of projectively equivalent properties.

The reader is referred to our Part 1 for the methods of generation and for all concepts which were already used in this context. We hope that the overview of all non-linear uniform reorientation classes will serve for many further investigations in the theory of oriented matroids.

We represent our complete overview of all uniform examples (Theorem 2.1. of Part 1) in a different form as Folkman Lawrence representations. The non-uniform case will be discussed in Section 3.

**1.1. Theorem.** There are altogether 24 reorientation classes of uniform non-linear oriented matroids in rank 4 with 8 points. Their Folkman-Lawrence representations are depicted in Appendix 1. The distribution of the number of mutations is as follows.

# mut.	7	8	9	10	11	12	13	14	15	16
# r.cl.	1	3	3	3	4	5	2	2	—	1

Our method of proving non-realizability was described in Part 1. The list of all non-linear examples in the appendix provides additional information summarized in Proposition 1.2. Oriented matroids without complete cells are of interest in connection with a problem of Larman, see Problem 12 in the list of problems of Roudneff, [20]. Euclidean oriented matroids play a special role in oriented matroid programming. Self duality

---

1980 Mathematics Subject Classification: Primary 05B35; Secondary 52A25 . Keywords: Oriented matroid, matroid, projective incidence theorem.

and symmetries are of interest in their own right. For the sake of completeness and for easy recognition, we add the reorientation class vector in each case.

**1.2. Proposition.** All non-linear reorientation classes are selfdual. There are 5 uniform non-linear euclidean reorientation classes. There are two uniform reorientation classes having no complete cells. There are only five one-point contraction types of all non-linear uniform reorientation classes. The symmetry groups of all uniform non-linear reorientation classes are given by their generators. The non-uniform example of Goodman and Pollack can be derived from a uniform example in our list. The former known uniform examples (to the best of our knowledge) are marked as well.

The similarity of the cycle structure of known final polynomials and Fukuda's cycling observation in oriented matroid programming led to an investigation and the following result of the second author which will be published elsewhere.

**1.3. Theorem.**(J. Richter-Gebert) A non-linear oriented matroid without a bi-quadratic final polynomial must be non-euclidean.

In other words, the search for bi-quadratic final polynomials contains Fukuda's method of proof (LP non-degenerate cycling) which guarantees an oriented matroid to be euclidean. Moreover, the search for bi-quadratic final polynomials can be accomplished by linear programming and therefore in polynomial time.

The *mutation graph* is defined as having for points all uniform oriented matroids of given rank and given number of points. Two points are connected by an edge if and only if they differ exactly by one sign (the mutation). The two adjacent oriented matroids are called mutants of each other. Las Vergnas and Cordovil have asked whether this graph always consists of a single component. Whereas in the realizable case this property is very easy to obtain, the problem is open for rank  $k > 3$ . We provide an affirmative answer to this question in the first non-trivial case where non-realizable oriented matroids are involved as well, namely in the (8,4) case.

**1.4. Theorem.** The mutation-graph of uniform oriented matroids is connected in the (8,4)-case.

The proof can be accomplished by the observation that each non-linear oriented matroid in our class has a linear mutant and the fact that the realizable subgraph is connected. Each mutation yielding a linear oriented matroid when switching its sign are marked in the appendix.

## 2. Bi-quadratic final polynomials

In deciding the representability of oriented matroids, *final polynomials* have been successfully applied. A first example of the first author appeared implicitly in [2]. A detailed description of the final polynomial method, a number of examples, and its connection to a real version of Hilbert's Nullstellensatz can be found in Bokowski and Sturmfels, [9], see also Sturmfels [22]. On one hand the existence of final polynomials in every non-representable case of an oriented matroid is a satisfactory theoretical answer but on the other hand, Hilbert's Nullstellensatz provides no efficient constructive way of finding final polynomials.

A practical constructive method for finding special classes of final polynomials via linear programming was given in [5]. But in general this method leads to very large final polynomials even if there exist smaller ones. In addition each final polynomial leads in general to a decision of representability only for the particular example under investigation. Some of the following final polynomials are a universal tool for classes of oriented matroids.

The notion of final polynomials can be formally introduced as follows. Let  $K[\Lambda(n, d)]$  be the polynomial ring over the field  $K$ . We consider the ideal  $I_\chi^K$  in  $K[\Lambda(n, d)]$  generated by the set of all non-bases  $\{[\lambda] \in \Lambda(n, d), \chi(\lambda) = 0\}$ .  $N_\chi^K$  is the set of all products with factors of the form  $\{[\lambda], \chi(\lambda) = +1\}$ ,  $\{-[\lambda], \chi(\lambda) = -1\}$ , or positive elements in the ordered field  $K$ .  $P_\chi^K$  is the quadratic semiring in  $K[\Lambda(n, d)]$  generated by  $N_\chi^K$  and the set of all squares of elements in  $K[\Lambda(n, d)]$ .

**2.1. Definition.**(Final polynomial):

A final polynomial for  $\chi$  is an element in the ring  $K[\Lambda(n, d)]$  with the property  $f \in I_{n,d}^K \cup (I_\chi^K + N_\chi^K + P_\chi^K)$ .

We present some bi-quadratic final polynomials as examples. They can be interpreted as one-line proofs for projective incidence theorems, e.g. the bundle condition, Pappos' theorem, and similar theorems have equally structured proofs.

**2.2. Example.**(Final polynomial for the bundle condition): see Kern [15], Bokowski, Sturmfels [8].

$$\begin{aligned}
 &+ \{12|3456\} [1347][1248][2347] + \{13|2457\} [1246][1248][2347] + \{14|2358\} [1246][1237][2347] \\
 &+ \{23|1467\} [1347][1248][1245] + \{24|1368\} [1347][1245][1237] + \{34|1278\} [1246][1245][1237] = \\
 &+ [1234][1256][1347][1248][2347] + [1234][1357][1246][1248][2347] + [1234][1458][1246][1237][2347] \\
 &+ [1234][2367][1347][1248][1245] + [1234][2468][1347][1245][1237] + [1234][3478][1246][1245][1237] = 0
 \end{aligned}$$

The geometric assertion of the bundle condition (Type 1) can be formulated as follows: pick 4 generic lines in a projective plane and pick two generic points on each line. For each pair of lines write down the bracket condition that they lie in the same plane. The bundle condition asserts that five conditions imply the remaining condition.

**2.3. Example.**(Final polynomial for Pappos' theorem)

$$\begin{aligned}
 &+ \{1|2479\} [148][157][347][467] + \{1|3478\} [149][247][157][467] + \{1|4567\} [148][247][347][179] \\
 &+ \{4|1267\} [148][157][347][179] + \{4|1357\} [148][247][167][179] + \{4|1789\} [247][157][167][134] \\
 &+ \{7|1459\} [247][148][167][134] + \{7|1468\} [247][157][149][134] + \{7|1234\} [149][148][157][467] = \\
 &+ [147][129][148][157][347][467] + [147][138][149][247][157][467] + [147][156][148][247][347][179] \\
 &+ [147][246][148][157][347][179] + [147][345][148][247][167][179] + [147][489][247][157][167][134] \\
 &+ [147][579][247][148][167][134] + [147][678][247][157][149][134] + [147][237][149][148][157][467] = 0
 \end{aligned}$$

In these examples we see that in the representable case of the oriented matroid, these polynomials have to be equal to zero. On the other hand, there are oriented matroids in all cases such that the sum of all monomials in the last polynomial has to be positive, which shows non-representability.

The final polynomial in 2.3. is remarkable since for oriented matroids in rank 3 we have the following:

**2.4. Theorem.**(J.Richter-Gebert and G. Gonzalez-Sprinberg, G.Laffaille) Pappos' theorem (oriented version) implies linearity for uniform oriented matroids in rank 3 with 9 points.

In the rank 4 case with 8 points, the final polynomial for the bundle condition was among those final polynomials we have chosen as a sufficient set to prove non-linearity. Interpreting all these three final polynomials in a geometric language, we are led to a result similar to Theorem 2.4. in which the 16-points projective incidence theorem is involved. Before we state our theorem, we formulate the projective incidence theorems we use, see Leisenring [16] and Herzer [14]. They can easily be proved in using our FP-graph calculus of Section 3. The essential formulas are similar to our Examples 2.2, 2.3. The following combinatorial tori of Type 2 and Type 3 serve as a description for our projective incidence theorems. Thus the theorem is easy to remember and symmetries are seen immediately.

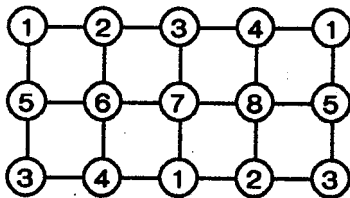

Type 2

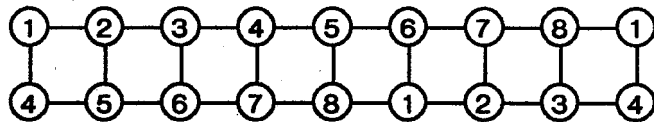

Type 3

**2.5. Theorem.**(16-points projective incidence theorem): We consider the generic case of 8 points in projective 3-space but with 7 linear dependent sets of 4 points each (those that form small squares in one of the above tori). The 4 vertices belonging to the remaining 8-th (combinatorial) square must then lie in a projective plane as well.

**2.6. Theorem.** The bundle condition (Type 1) and the oriented versions (Type 2 and Type 3) of the foregoing projective incidence theorems (2.5.) imply linearity for uniform oriented matroids in rank 4 with 8 points.

The key for the geometric flavor of this assertion lies in analysing our final polynomials and looking at corresponding periodic graphs whereby points correspond to entries of a formal Tucker matrix (=standard representative matrix). The proof of the theorem will be given in the next section.

There was an additional motivation for starting our investigation, namely to check whether our methods for testing realizability were sufficient in these cases. It turned out that all final polynomials were bi-quadratic which leads to Problem 2.7. If true one would decide realizability of oriented matroids in polynomial time.

**2.7. Problem.** Does there exist a bi-quadratic final polynomial in each non-linear case?

### 3. Graphs representing bi-quadratic final polynomials

In this section we analyse final polynomials in terms of graphs. We consider periodic bi-partite graphs on two-dimensional lattice points, having a formal Tucker matrix or a formal standard representative matrix in mind. We call these graphs *FP-graphs* because of their close connection to final polynomials. In starting with such an FP-graph, it is possible to construct new projective incidence theorems and new final polynomials for other oriented matroids.

**Definition 3.1.** An *FP-graph* is defined as a  $(p_x, p_y)$ -periodic bi-partite graph on lattice points in the plane  $Z^2 = \{(x, y) | x \in Z, y \in Z\}$  with the following properties.

1. The graph has periods of length  $p_x$  and  $p_y$  in directions  $x$  and  $y$ , respectively.
2. Every point lies in an even number of opposite edges.
3. There is a partition of the edges of the graph into opposite pairs, each pair forming the two diagonals of a rectangle parallel to the axis.

In general we assume that there are no empty rows or columns in the fundamental region. We say a final polynomial of a (partial) oriented matroid with  $p_x + p_y$  points in rank  $p_x$ , or in rank  $p_y$ , respectively, has an FP-graph, i.e. a  $(p_x, p_y)$ -periodic bi-partite graph if the following structure occurs:

**3.2. Theorem.** The final polynomials confirming non-linearity for oriented matroids with 8 points in rank 3 and 9 points in rank 3 have FP-graphs.

We consider the final polynomial of Pappos' theorem. We consider 9 formal points (the points might not exist) in the plane with homogeneous coordinates. We assume a fixed base of three points such as [148] in Pappos' example, and we consider the corresponding formal Tucker matrix depicted in the rectangle below. The final polynomial can be viewed as constructed out of all  $2 \times 2$ -determinants having in the periodic picture two dotted diagonals. Compare the corresponding Graßmann Plücker relations:

$$\{1|2479\}, \{1|3478\}, \{1|4567\}, \{4|1267\}, \{4|1357\}, \{4|1789\}, \{7|1459\}, \{7|1468\}, \{7|1234\}$$

The final polynomial consists of entries in the Tucker matrix. The fact that corresponding brackets cancel depends on the distribution of the dotted lines. Each entry in the matrix has half of its edges as bold edges. In other words, the bold diagonal in the  $2 \times 2$ -determinant determines the *sign* of this determinant when generating the final polynomial. The reader not familiar with the Tucker matrix concept can read more about this topic in [7].

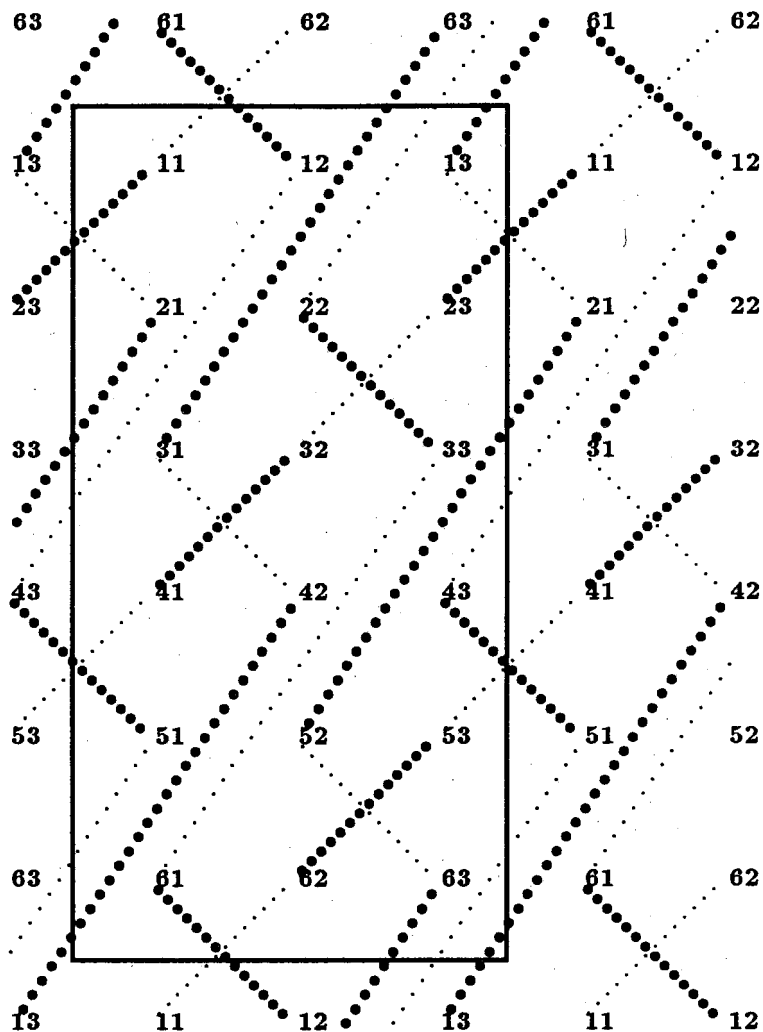

**Example 3.5.** A  $(3,6)$ -periodic bi-partite graph on lattice points in the plane. This *FP-graph* leads in a canonical way to a final polynomial for Pappos' theorem.

**Remark 3.6.** It is easily seen that finding a final polynomial for 12 points in rank 6 is no problem. More generally, glueing together several patches leads to an infinite series of *FP-graphs* of final polynomials. In general there is a freedom to connect suitable pairs in the graph when several patches are glued together. This shows a huge variety of final polynomials even for fixed rank and a fixed number of points.

In the case of Pappos' theorem we have seen how to carry over the *FP-graph* structure to a final polynomial. Therefore it suffices to present the three *FP-graphs* for our Theorem 2.6. In the following we present the three  $(4,4)$ -periodic *FP-graphs* corresponding to the bundle condition (Type 1) and two essential variants (Type 2 and Type 3) of the 16-points theorem in projective geometry, respectively.

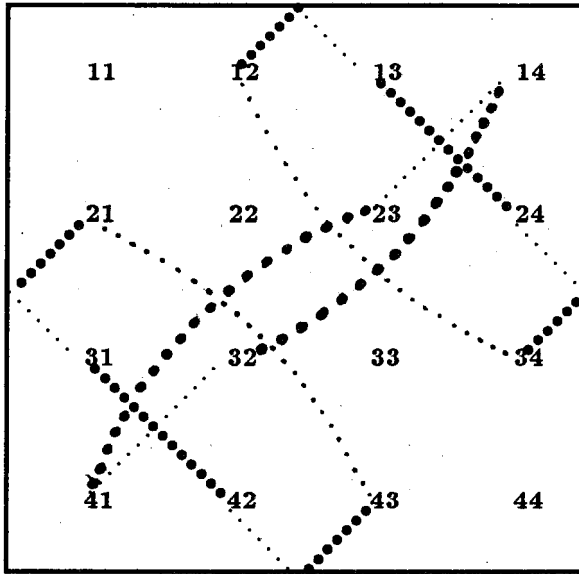

**3.7. Example.** The fundamental region of a  $(4,4)$ -periodic FP-graph. It corresponds to the final polynomial (Type 1) for the bundle condition (oriented Vamos).

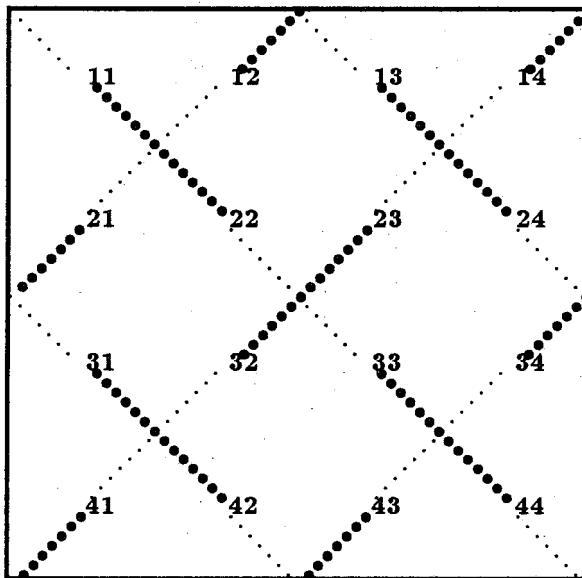

**3.8. Example.** The fundamental region of a  $(4,4)$ -periodic FP-graph. It corresponds to a final polynomial (Type 2) for a variant of the 16-points theorem.

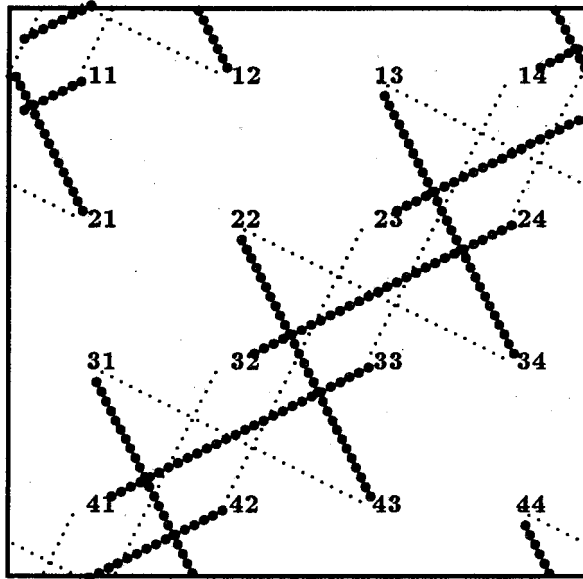

**3.9. Example.** The fundamental region of a (4,4)-periodic FP-graph. It corresponds in a canonical way to a final polynomial (Type 3) for a variant of the 16-points theorem.

**3.10. Example.** (Altshuler's non-polytopal sphere  $M_{10}^{425}$  revisited)

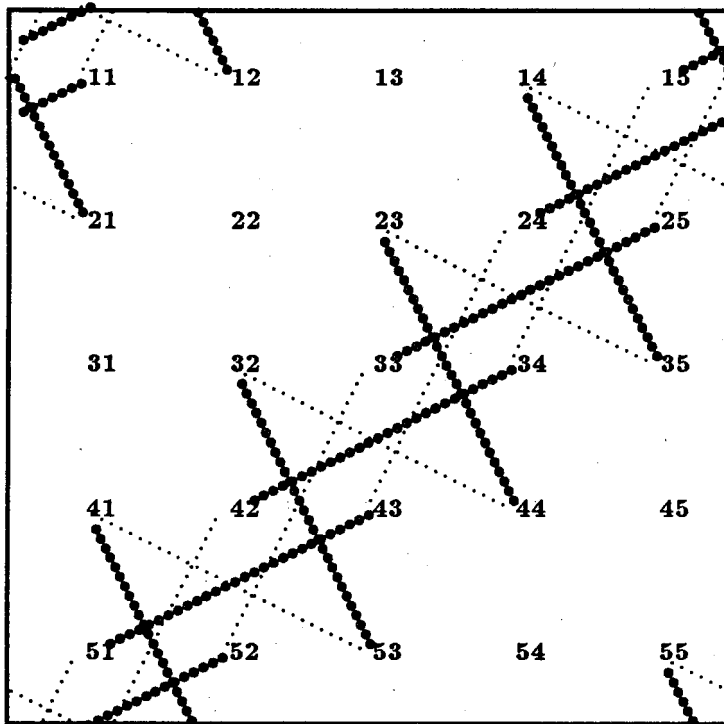

**Example A** A (5,5)-periodic FP-graph (fundamental region) which corresponds to a non-representable proof for Altshuler's sphere  $M_{10}^{425}$ . Compare also Example 3.9. to see the analog to the 16-points theorem in projective geometry.

Goodman and Pollack have shown that Levi's enlargement lemma does not carry over to pseudo-plane arrangements, [13]. Their example is non-uniform. We can start with Example 4 in our list and shrink all mutations but one to just a point. All mutations are non-adjacent. Observing the final polynomial while



shrinking these mutations shows that some additional summands in the polynomial are zero. This does not affect the argument in the proof of non-linearity. In the same way that we derive the example of Goodman and Pollack out of a uniform example, we can construct whole classes of non-uniform non-linear reorientation classes.

We call a set of mutations non-adjacent if no two of them (considered as topes in the Folkman Lawrence representation) have a point on the sphere in common. A set of mutations covers a final polynomial if each summand in the final polynomial contains at least one mutation.

**4.2. Theorem** Each non-adjacent set of mutations not covering all summands in a final polynomial leads to a non-uniform non-linear oriented matroid.

We finally mention that the Fukuda Mandel example FM(8) is the last example in our list whereas the Altshuler Roudneff example AR(8) is No. 2 in our list. The latter example was presented on the Bremen Mathematics Exhibition 1990 as a model of its Folkman Lawrence representation. See also the picture. The model shows this smallest non-representable pseudo-plane arrangement in projective 3-space with 8 pseudo-planes which has the smallest number of tetrahedral regions.

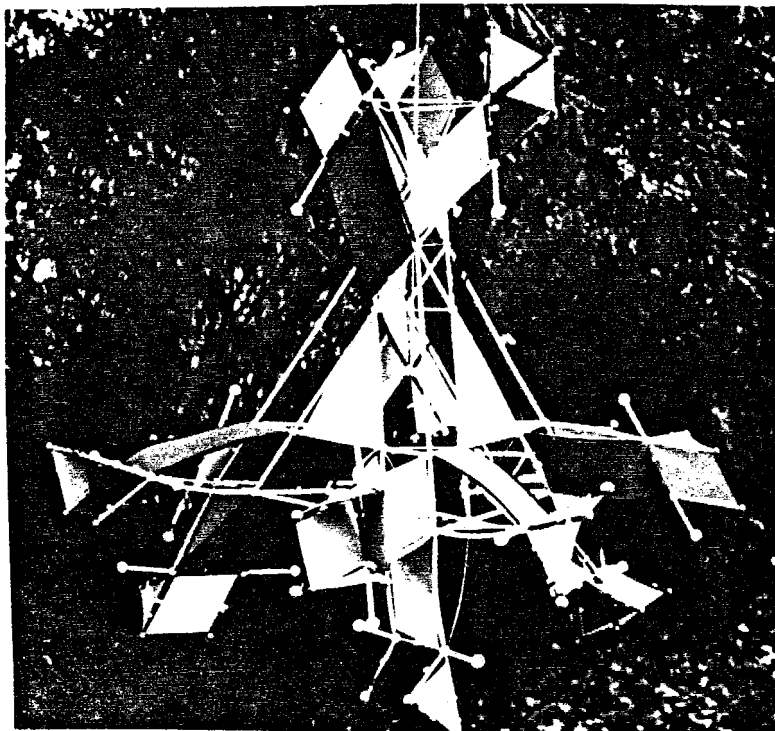

Eight planes are defined by the affine hull of the 4 facets of the central inner tetrahedron together with the affine hull of the 4 facets of its homothetic outer tetrahedron. Towards the plane at infinity, these 8 planes are deformed to pseudo-planes as indicated in the picture in order to have a *simple arrangement of pseudo-planes*, i.e. only 3 pseudo-planes meet in a common point. When the tetrahedral symmetry is maintained, we see for each edge of the simplex a tetrahedral region having a 4-gon as intersection with the plane at infinity. Together with the central tetrahedron, we have 7 tetrahedral cells of maximal dimension.

**Acknowledgement.** The first author wishes to thank A. Herzer for helpful discussions and for drawing our attention to the 16-points theorem in projective geometry.

## References

- [1] Al Dahir, M. W., A simplified proof of the Pappus-Leisenring Theorem, *Mich. Math. J.* 4 (1957), 225 - 226.
- [2] Altshuler, A., Bokowski, J., Steinberg, L., The classification of simplicial 3-spheres with nine vertices into polytopes and non-polytopes. *Discrete Mathematics* 31 (1980) 115 - 124.
- [3] Bland, R., Las Vergnas, M., Orientability of matroids. *J. Combinatorial Theory B* 24 (1978) 94-123.
- [4] Bokowski, J., Garms, K. Altshuler's sphere  $M_{425}^{10}$  is not polytopal. *European J. Combinatorics* 8 (1987) 227 - 229.
- [5] Bokowski, J., Richter, J., On the finding of final polynomials, *Europ. J. Comb.*, 11 (1990) 21-34.
- [6] Bokowski, J., Richter-Gebert, J., On the classification of non-realizable oriented matroids, Part 1.
- [7] Bokowski, J., Richter, J., Sturmfels, B. Nonrealizability proofs in computational geometry, *Discrete Comput. Geometry*, 5 (1990) 333-350.
- [8] Bokowski, J. ; Sturmfels, B., Reell realisierbare orientierte Matroide. *Bayeuther Math. Schriften* 21 (1986) 1 - 13.
- [9] Bokowski, J., Sturmfels, B., Computational synthetic geometry, *Springer Lecture Notes* 1355 (1989).
- [10] Folkman, J., Lawrence, J., Oriented matroids, *J. Comb. Theory, Ser. B*, 25 (1978) 199-236.
- [11] Fukuda, Oriented matroid programming, Ph.D.Thesis, 1982, Waterloo.
- [12] Gonzalez-Sprinberg, G., Laffaille, G., Une algorithmique des arrangements dans le plan projectif, Preprint No. 145, U. Grenoble, 1989.
- [13] Goodman J.E., Pollack R., Three points do not determine a (pseudo-)plane. *J. Comb. Theory, Ser. A*, 31No. 2 (1981) 215-218.
- [14] Herzer, A. Ableitung zweier selbstdualer, zum Satz von Pappos äquivalenter Schließungssätze aus der Konstruktion von Dualitäten. *Geometriae Dedicata* bf 2 (1973) 283 - 310.
- [15] Kern, W. Verbandstheoretische Dualität in kombinatorischen Geometrien und orientierten Matroiden. Ph. D. Thesis, Köln (1985).
- [16] Leisenring, K.B., A theorem in projective n-space equivalent to commutativity. *Mich. Math. J.* bf 2 (1953/54), 35 - 40.
- [17] Mandel, A., Topology of oriented matroids, Dissertation, University of Waterloo, (1982), 333 pages.
- [18] Richter, J., Kombinatorische Realisierbarkeitskriterien für orientierte Matroide, *Mitteilungen aus dem Math. Sem. Gießen* 194 (1989), 113 p.
- [19] Roudneff, J.-P. Matroides orientes et arrangements de pseudo-droites. Thèse, Paris, (1987).
- [20] Roudneff, J.-P. List of problems, Paris, (1987).
- [21] Roudneff, J.-P., Sturmfels, B., Simplicial cells in arrangements and mutations of oriented matroids, *Geometriae Dedicata* 27 (1988) 153-170.
- [22] Sturmfels, B., Computing final polynomials and final syzygies using Buchberger's Gröbner basis method, *Results in Math.*, 15 (1989) 551-360.
- [23] White, N., The bracket ring of a combin. geometry. I, *Trans. Amer. Math. Soc.* 202 (1975) 79-103.
- [24] Ziegler, G. M., Linear programming in oriented matroids, *Report No. 195*, U. Augsburg 1990.

University of Darmstadt  
Mathematics Department  
Schlossgartenstrasse 7  
6100 Darmstadt, F.R.G.

e-mail: XBR1DB0N at DDATHD21.bitnet

final polynomial 3

final polynomial 1, non euclidean, oriented Vamos

final polynomial 2

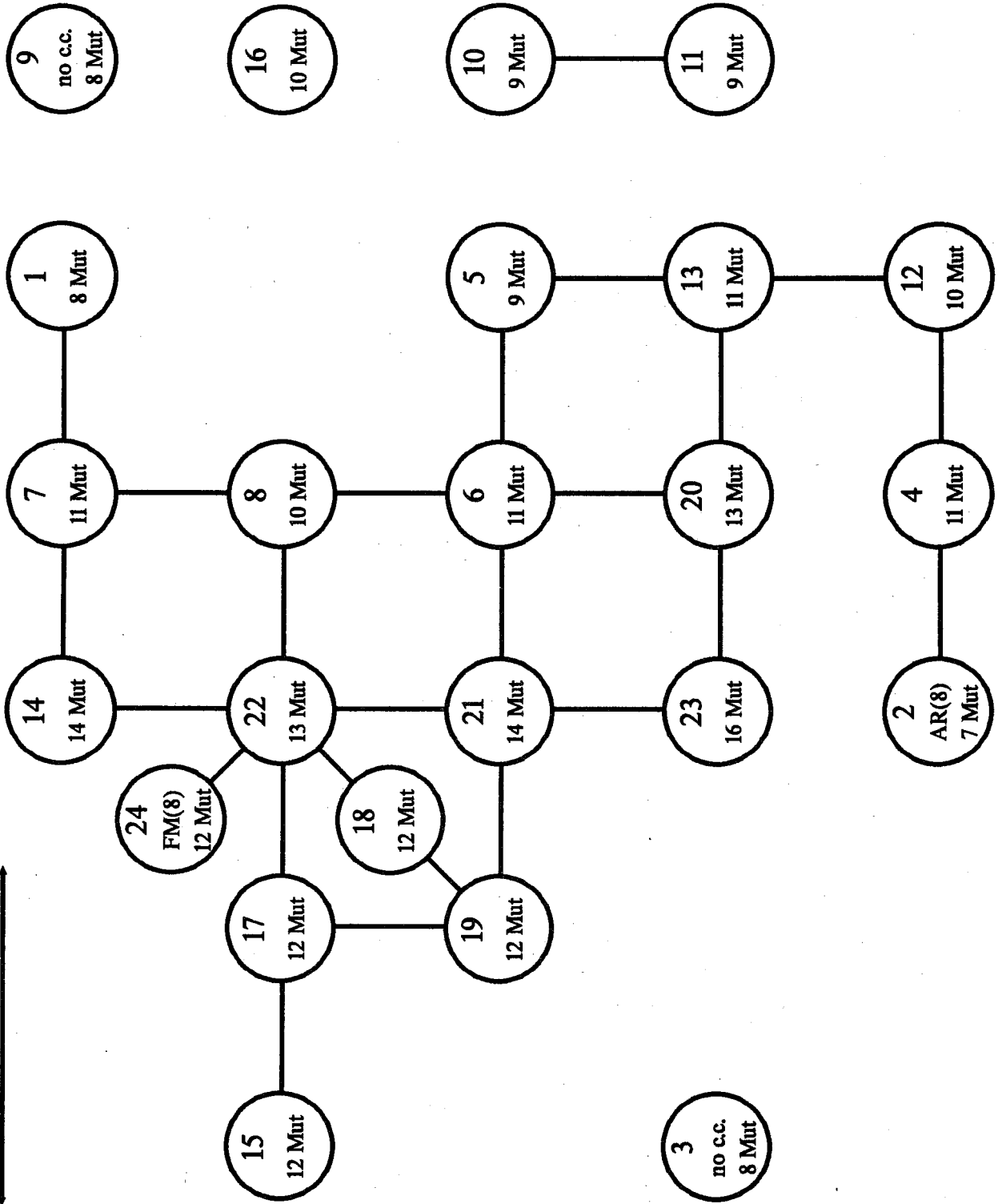

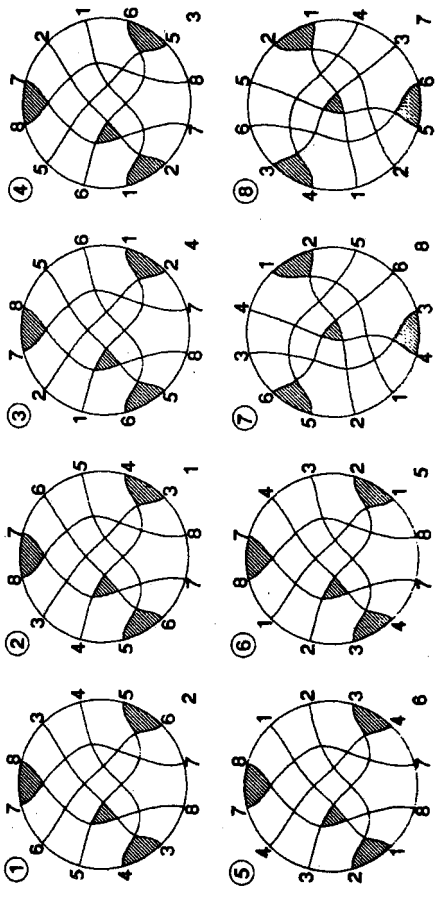

1

Final polynomial Type 1, non-euclidean.

Symmetry group: 12345678 56123478 34561278 21654387 43216587 65432187.

Bases: ++++++-----  
Mutations: 1234, 1256, 1278, 1358, 1368, 2467, 3456, 3478, 5678.

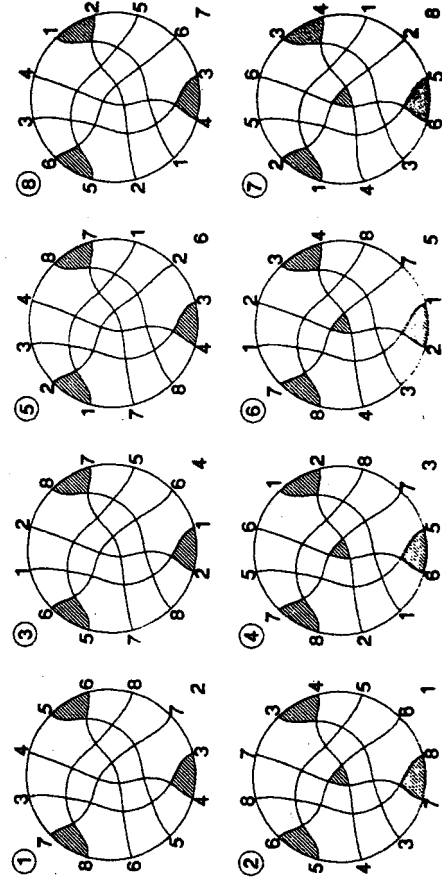

2

The Altshuler-Roundneff example AR(8), final polynomial Type 1, non-euclidean.

Symmetry group: 12345678 12873465 12568743 34128765 56123478 87125643  
34561278 87341265 56871243 34875621 56348721 87563421

Bases: ++++++-----  
Mutations: 1234, 1256, 1278, 2467, 3456, 3478, 5678.

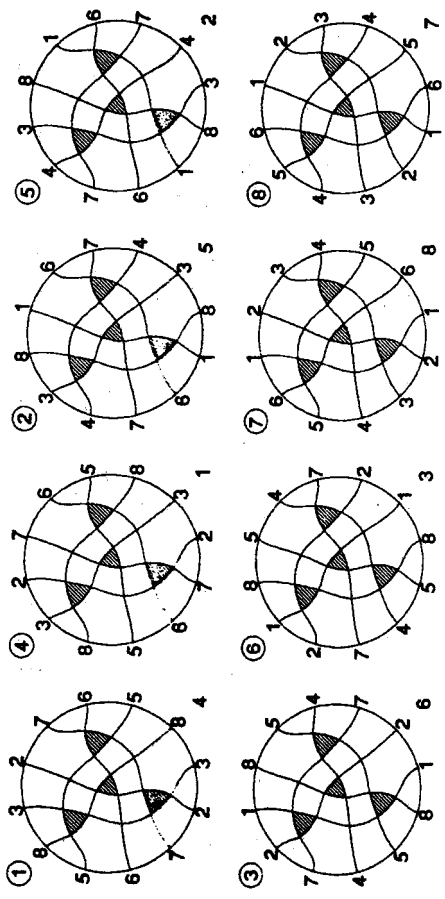

3

Reorientation class with highest symmetry, final polynomial Type 2, euclidean, there is no complete cell.

Symmetry group: 12345678 18547236 16743852 21854763 61234587 81674325  
72185436 56123478 38167452 47218563 45612387 43816725

Bases: ++++++-----  
Mutations: 1217, 1208, 1168, 1607, 2348, 2407, 3467, 4508.

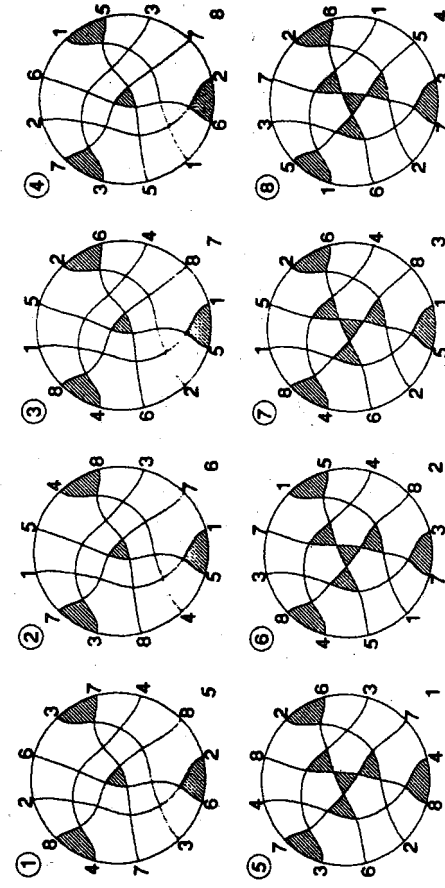

4

Final polynomial Type 1, non-euclidean.

Symmetry group: 12345678 14235867 13425786 21436587 31247588 41328576  
23146758 42138657 34127856 24316875 32417685 43218765

Bases: ++++++-----  
Mutations: 1256, 1357, 1458, 1678, 2307, 2468, 2578, 3478, 3568, 4567, 5678.

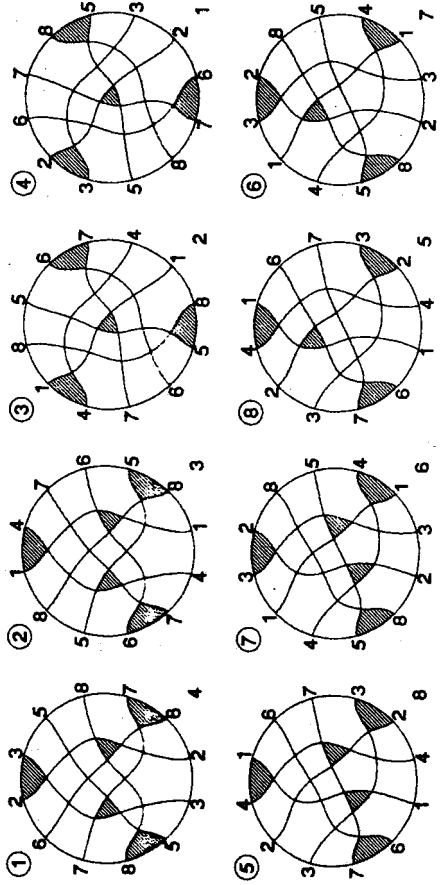

5

Final polynomial Type 1, non-euclidean.

Symmetry group: 12345678 21437856

Bases: +-----+-----+-----+-----+-----+-----+-----+-----+-----+-----+  
 Mutations: 1234, 1268, 1268, 1357, 1458, 1467, 1467, 2358, 2367, 2457, 5678.

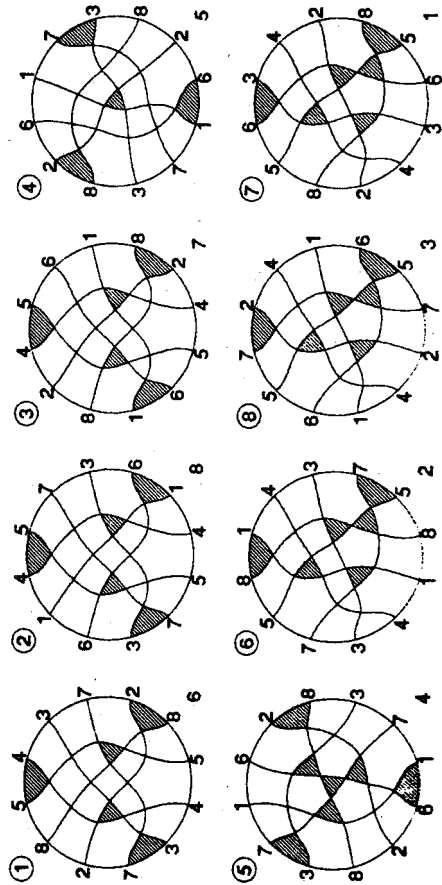

7

Final polynomial Type 1, non-euclidean.

Symmetry group: 12345678 31245786 23145867

Bases: +-----+-----+-----+-----+-----+-----+-----+-----+-----+-----+  
 Mutations: 1234, 1268, 1367, 1456, 1578, 2378, 2458, 2567, 3457, 3568, 5678.

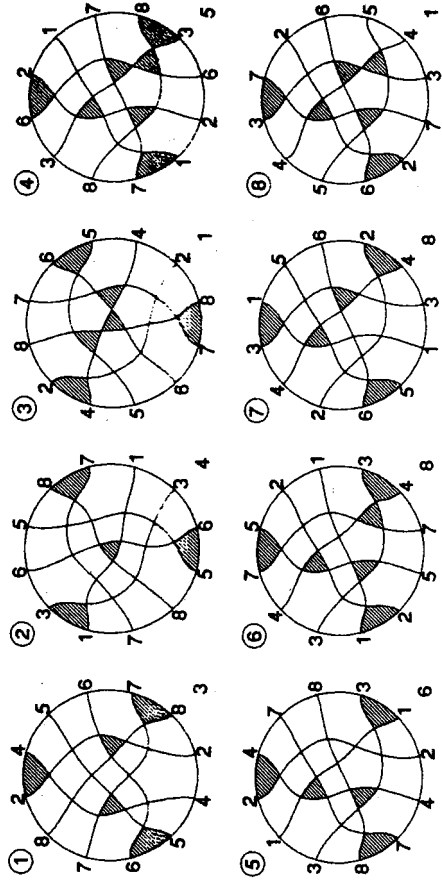

6

Final polynomial Type 1, non-euclidean.

Symmetry group: 12345678

Bases: +-----+-----+-----+-----+-----+-----+-----+-----+-----+-----+  
 Mutations: 1234, 1268, 1356, 1378, 1457, 2456, 2478, 3458, 3467, 3468, 5678.

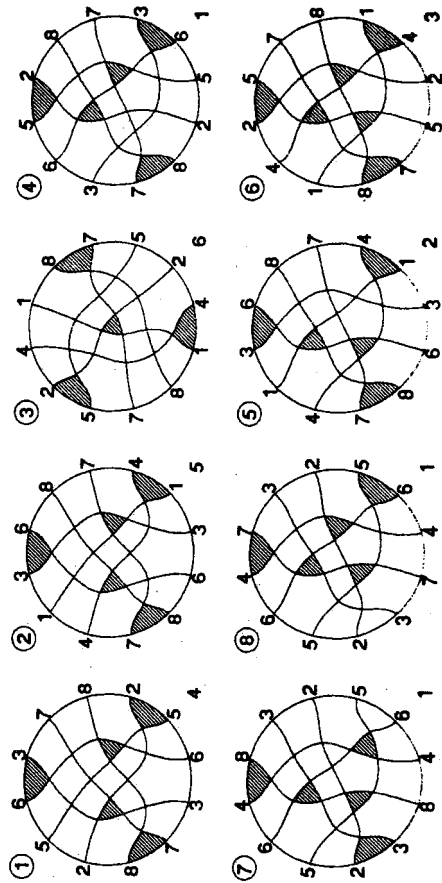

8

Final polynomial Type 1, non-euclidean.

Symmetry group: 12345678

Bases: +-----+-----+-----+-----+-----+-----+-----+-----+-----+-----+  
 Mutations: 1237, 1245, 1346, 1478, 1568, 2356, 2466, 2578, 3678, 4567.

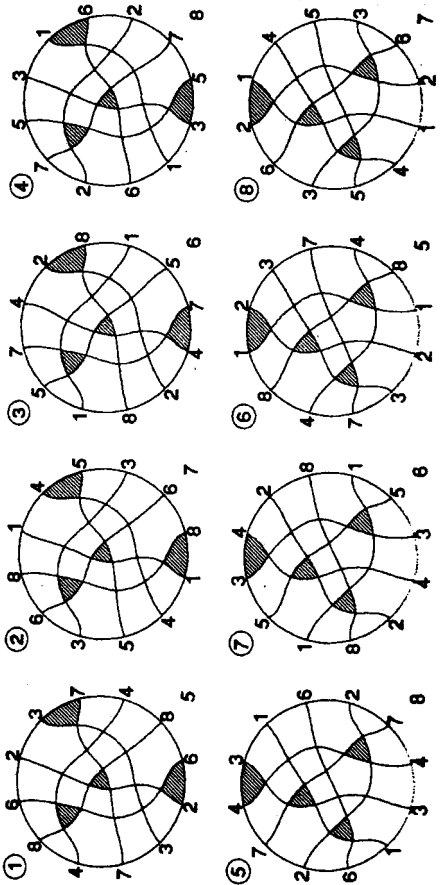

9

Final polynomial Type 3, euclidean, there is no complete cell.

Symmetry group: 12345678 21437856 43128567 34216785

Bases: +-----+-----+-----+-----+-----+-----+-----+-----+-----+-----

Mutations: 1256, 1278, 1357, 1468, 1467, 1467, 2356, 2457, 3458, 3467.

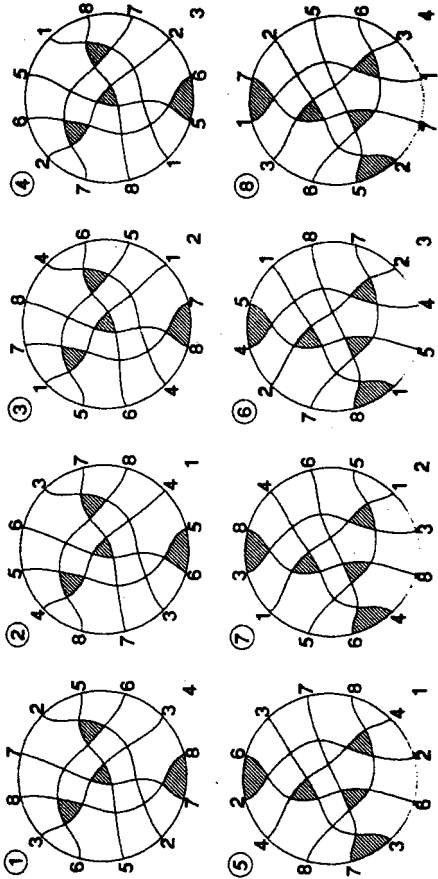

10

Final polynomial Type 3, euclidean.

Symmetry group: 12345678 41238756 34126587 23417865

Bases: +-----+-----+-----+-----+-----+-----+-----+-----+-----+-----

Mutations: 1256, 1357, 1368, 1478, 2378, 2458, 2467, 3456, 5678.

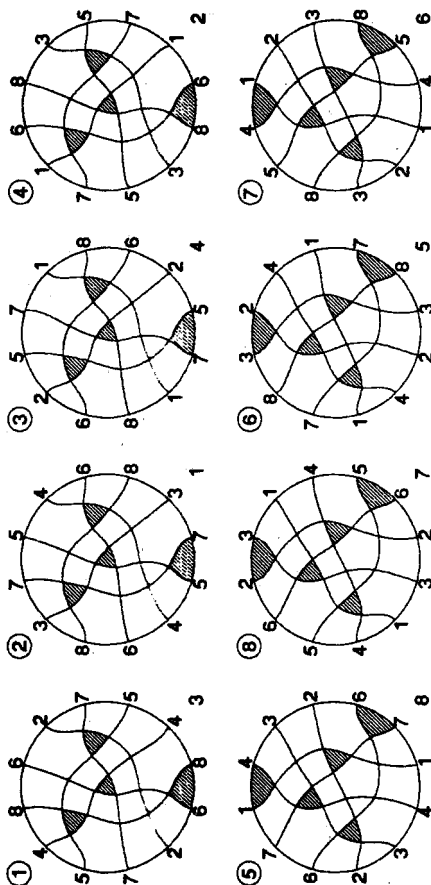

11

Final polynomial Type 3, euclidean.

Symmetry group: 12345678 31426785 24138567 43217856

Bases: +-----+-----+-----+-----+-----+-----+-----+-----+-----+-----

Mutations: 1257, 1368, 1458, 1467, 2356, 2378, 2468, 3457, 5678.

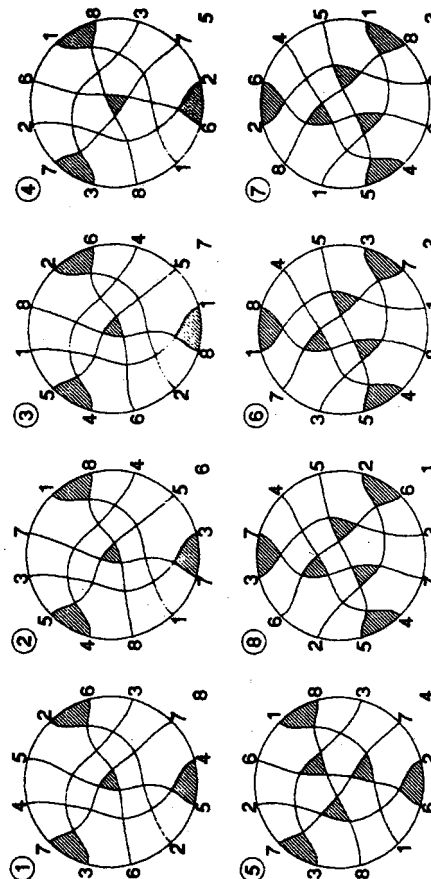

12

Final polynomial Type 1, non-euclidean.

Symmetry group: 12345678 31245867 23145786

Bases: +-----+-----+-----+-----+-----+-----+-----+-----+-----+-----

Mutations: 1268, 1378, 1458, 1567, 2367, 2456, 2578, 3457, 3568, 4678.

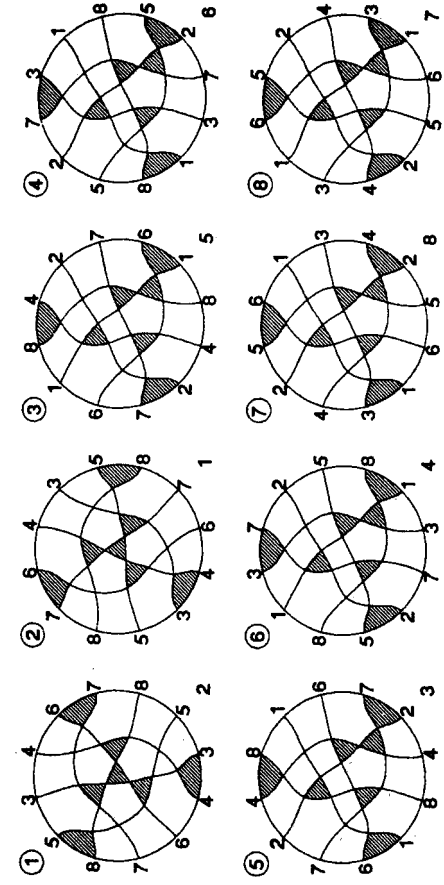

14

Final polynomial Type 1, non-euclidean.

Symmetry group: 12345678 12857346 12674853 21436587 21583764 21768435

Bases: +-----+-----+-----+-----+-----+-----+-----+-----+-----+-----+  
 1234, 1258, 1267, 1356, 1368, 1378, 1468,  
 Mutations: 2357, 2456, 2457, 2478, 3458, 3467, 5678.

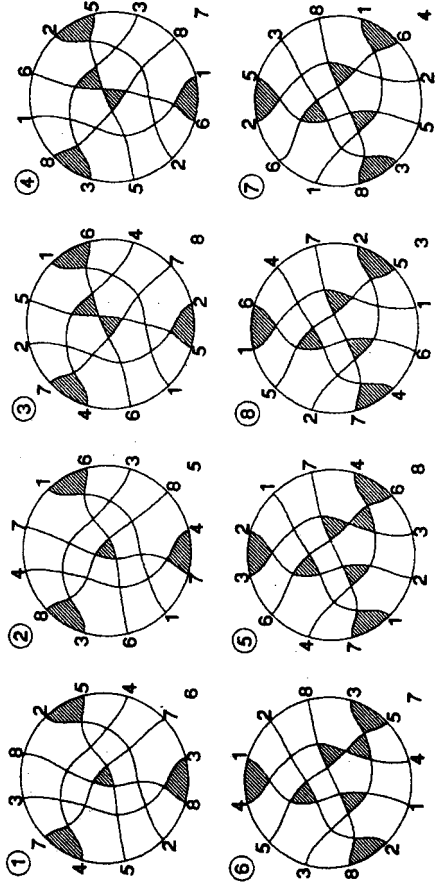

13

Final polynomial Type 1, non-euclidean.

Symmetry group: 12345678 21436587

Bases: +-----+-----+-----+-----+-----+-----+-----+-----+-----+-----+  
 1256, 1368, 1467, 1578, 2358, 2457, 2678, 3456, 3478, 3567, 4568.

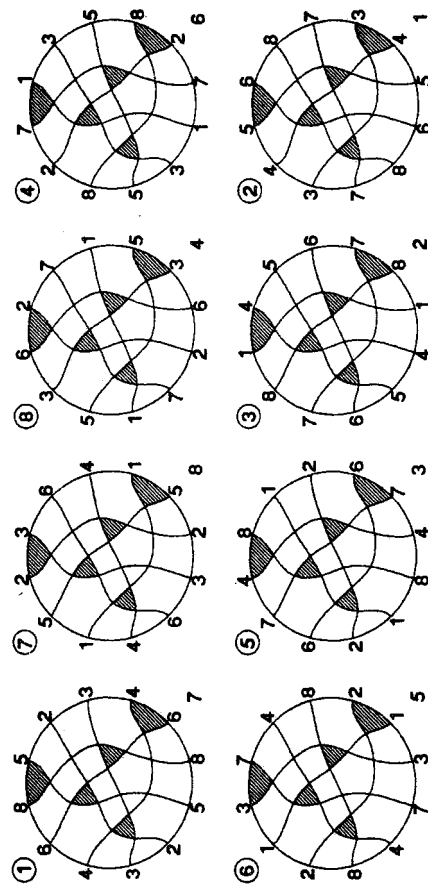

16

Final polynomial Type 3, euclidean.

Symmetry group: 12345678 87152346 64827153 35674821

Bases: +-----+-----+-----+-----+-----+-----+-----+-----+-----+-----+  
 1234, 1256, 1368, 1467, 1578, 2378, 2457, 2468, 3458, 3567.

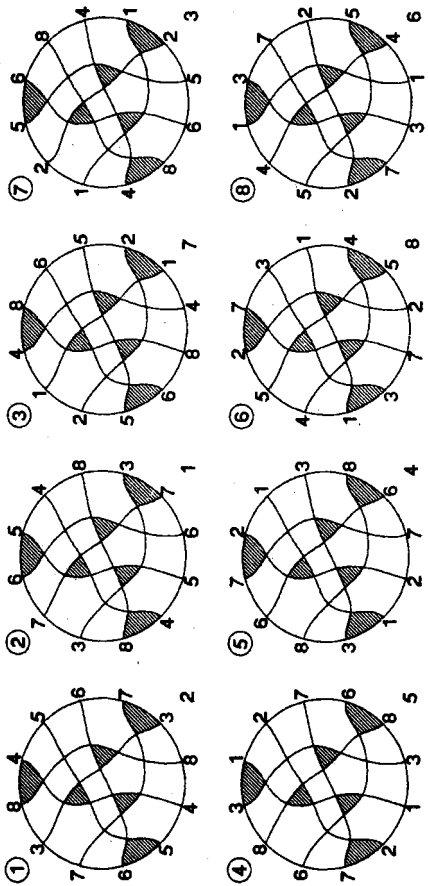

15

Final polynomial Type 2, euclidean.

Symmetry group: 12345678 21754836 37186524 45812763 54621387 68573142 73268415 86437251

Bases: +-----+-----+-----+-----+-----+-----+-----+-----+-----+-----+  
 1237, 1248, 1256, 1345, 1368, 1467, 2358, 2457, 2678, 3478, 3567, 4568.

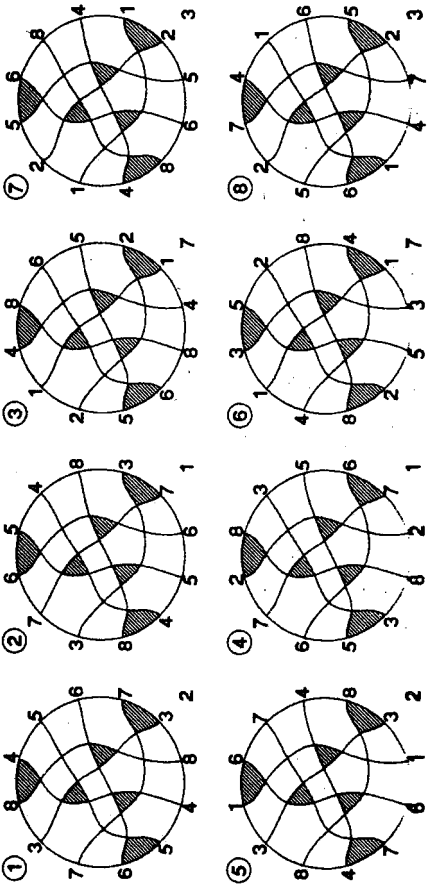

17

Final polynomial Type 1 and Type 2, non-euclidean.

Symmetry group: 12345678 21754836 37186524 73268415

Bases: ++++++-----  
 Mutations: 1237, 1248, 1256, 1345, 1368, 1467, 2358, 2457, 2678, 3478, 3567, 4568.

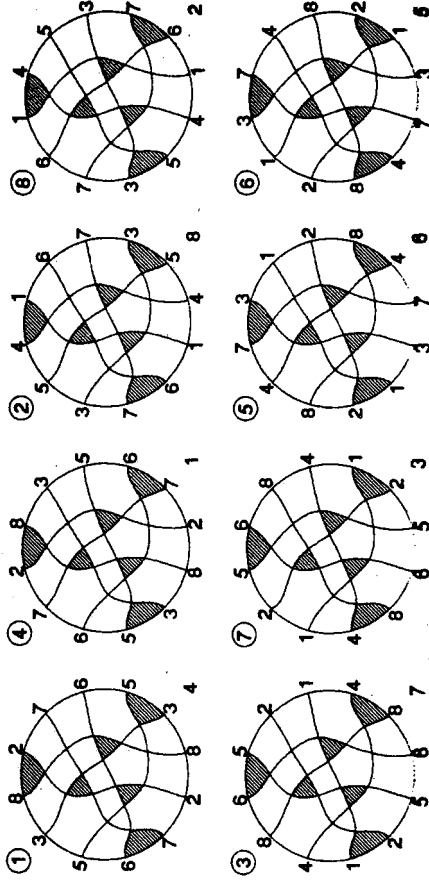

18

Final polynomial Type 1 and Type 2, non-euclidean.

Symmetry group: 12345678 21583764 67152843 48716532 76231485 35874126 53468217 8462731

Bases: ++++++-----  
 Mutations: 1237, 1248, 1256, 1345, 1368, 1467, 2358, 2457, 2678, 3478, 3567, 4568.

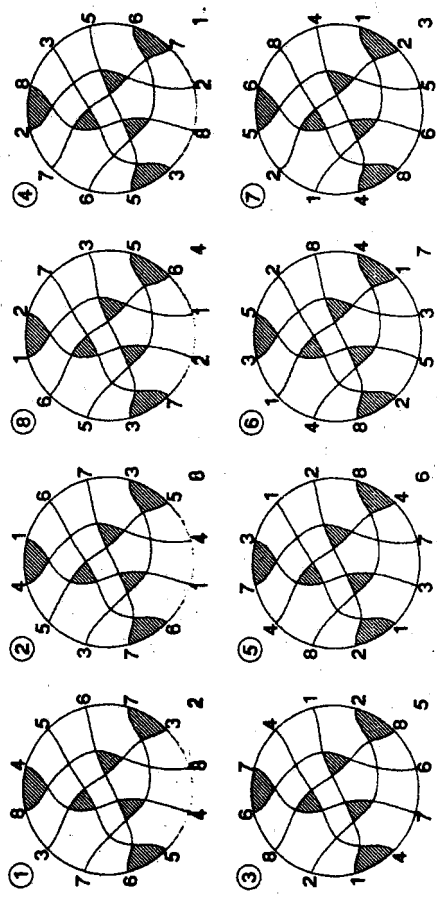

19

Final polynomial Type 1 and Type 2, non-euclidean.

Symmetry group: 12345678 41783562 28516734 56431287 35874126 73268415 84627351

Bases: ++++++-----  
 Mutations: 1237, 1248, 1256, 1345, 1368, 1467, 2358, 2457, 2678, 3478, 3567, 4568.

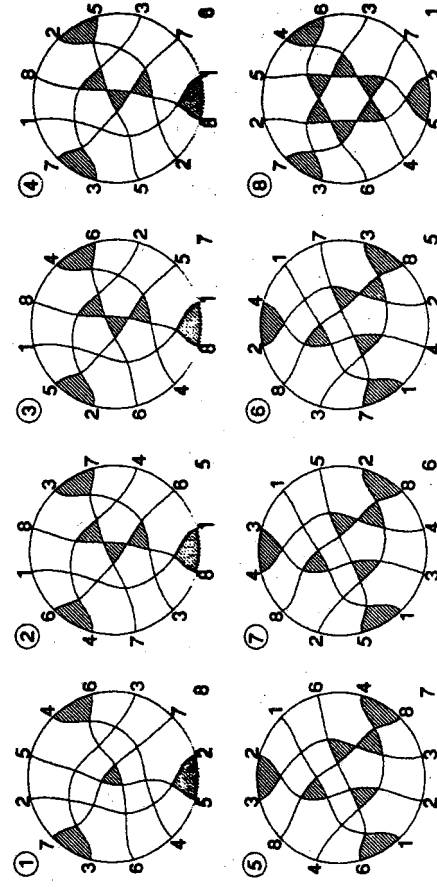

20

Final polynomial Type 1, non-euclidean.

Symmetry group: 12345678 14236758 13427568

Bases: ++++++-----  
 Mutations: 1258, 1378, 1468, 1567, 2357, 2368, 2456, 2478, 2678, 3458, 3467, 3568.



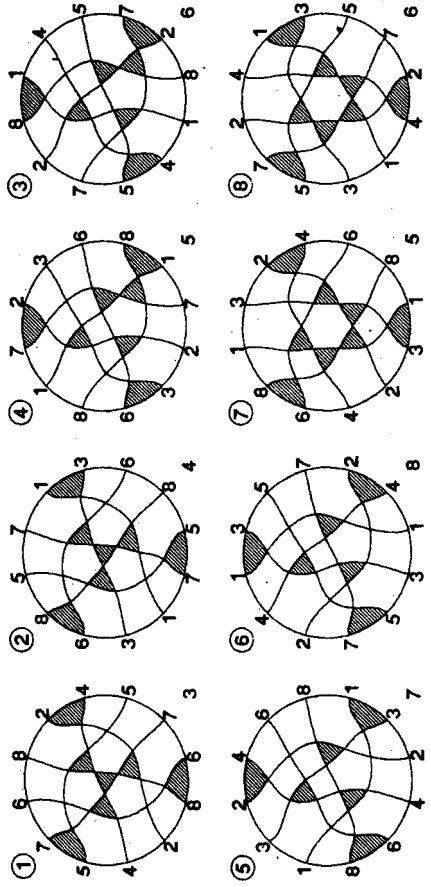

21

Final polynomial Type 1, non-euclidean.

Symmetry group: 12345678 21436587

Bases: ++++++-----  
 Mutations: 2358, 2367, 2378, 2457, 2468, 3456, 5678.

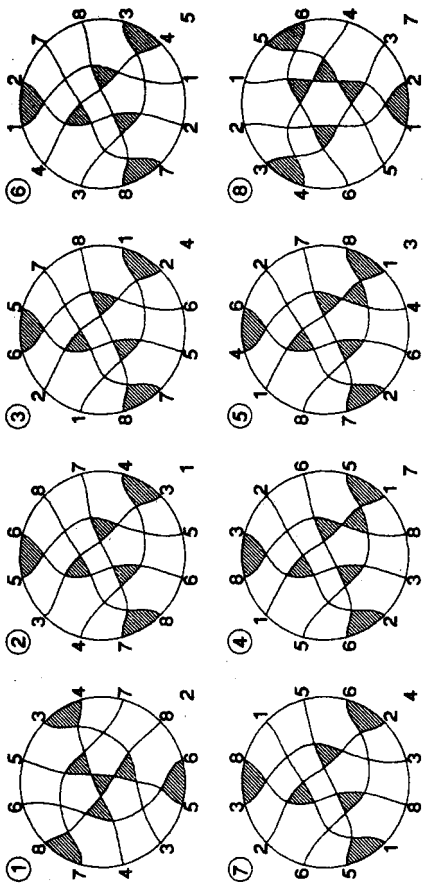

22

Final polynomial Type 1, non-euclidean.

Symmetry group: 12345678

Bases: -----  
 Mutations: 1234, 1256, 1278, 1358, 1457, 1468, 2357, 2368, 2467, 3456, 3478, 5678

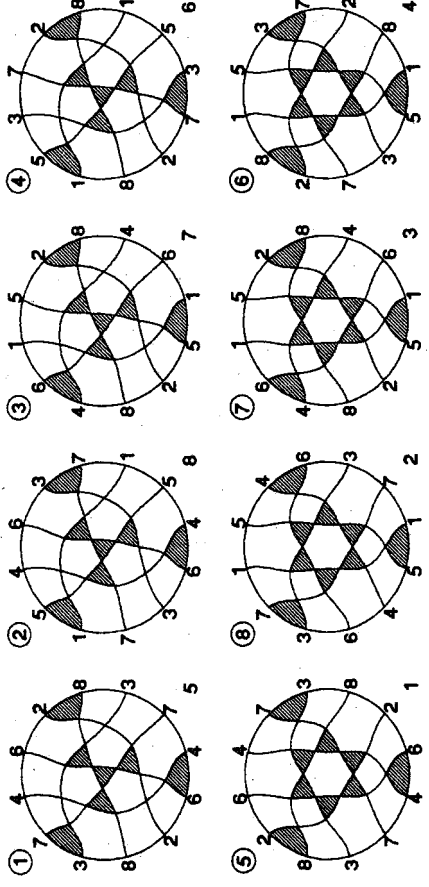

23

Final polynomial Type 1, non-euclidean.

Symmetry group: 12345678 14235786 13428765 31247685 41326875  
 23148657 42136758 34127856 24318576 32417568 43216587

Bases: -----  
 Mutations: 1258, 1267, 1357, 1368, 1456, 1478, 1678, 2356,  
 2378, 2457, 2468, 2567, 3458, 3467, 3568, 4578.

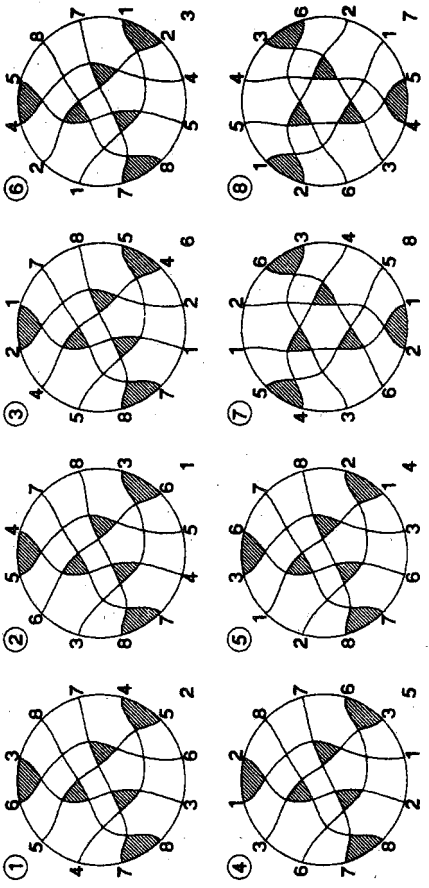

24

The Fukuda-Mandel example FM(8), final polynomial Type 1, non-euclidean.

Symmetry group: 12345678 63512478 45263178 21436587 36154287 54621387

Bases: ++++++-----  
 Mutations: 1236, 1245, 1278, 1347, 1358, 1567, 2348, 2467, 2568, 3456, 3678, 4578.