

ZONOTOPAL TILINGS AND THE BOHNE-DRESS THEOREM

JÜRGEN RICHTER-GEBERT AND GÜNTER M. ZIEGLER

ABSTRACT. We prove a natural bijection between the polytopal tilings of a zonotope Z by zonotopes, and the one-element-liftings of the oriented matroid $\mathcal{M}(Z)$ associated with Z . This yields a simple proof and a strengthening of the Bohne-Dress Theorem on zonotopal tilings. Furthermore we prove that not every oriented matroid can be represented by a zonotopal tiling.

0. INTRODUCTION.

At the 1989 Stockholm “Symposium on Combinatorics and Geometry”, Andreas Dress announced the following surprising theorem: The tilings of a zonotope Z by zonotopes are in bijection with the single-element liftings of the associated oriented matroid $\mathcal{L}(Z)$ [5]. A proof was provided in the 1992 doctoral dissertation of Jochen Bohne [3]. (A zonotope is, to give three equivalent characterizations, a projection of a cube, a Minkowski sum of line segments, and a polytope all of whose faces are centrally symmetric [4] [14] [2, Sect. 2.2].)

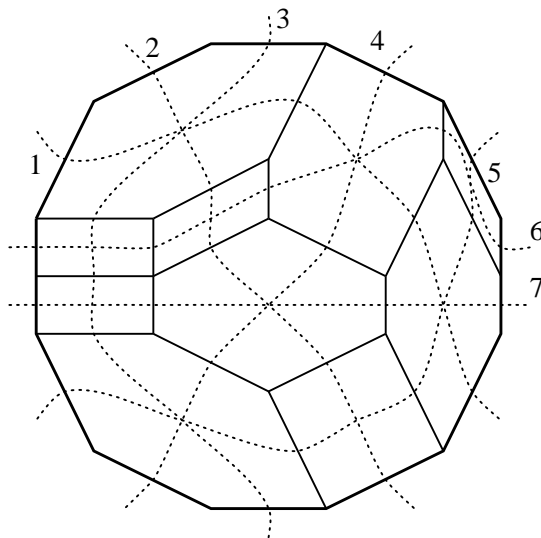

This result is remarkable, because it yields a perfectly straight, euclidean representation also for the non-realizable oriented matroids (pseudo-arrangements) that have a realizable one-element contraction. For example, for $d = 2$ it provides

1991 *Mathematics Subject Classification.* 05B35, 52B40; Secondary 52C22, 52B11.

Key words and phrases. Oriented Matroids, Zonotopes, Tilings, Convex Polytopes.

Supported by a grant in the “Gerhard-Hess Programm” of the German Science Foundation.

a canonical bijection between the (affine) arrangements with n parallel classes of pseudolines and the zonotopal tilings of regular $2n$ -gons.

Both directions of the Bohne-Dress Theorem are decidedly non-trivial. However, we will show how major parts can be reduced to basic combinatorial and geometric results in the theory of oriented matroids. With this, the present note provides easy and reasonably short proofs. Nevertheless, our version also contains various parts and ideas from the original proofs in [3]. Our main new ideas resp. technical improvements are the following:

- in the part “from oriented matroids to tilings” (Section 2) we use a volume argument, which replaces the harder part of the proof that we get a tiling,
- in the part “from tilings to oriented matroids” (Section 4) we formulate and use a handy criterion (Theorem 4.1) to see from a “deletion & contraction argument” that a geometric situation represents an oriented matroid.

At the same time, we also extend the Bohne-Dress result. Bohne’s definition of a zonotopal tiling in [3, Def. 1.3] (“zonotopale Pflasterung”: this is what we call a *strong zonotopal tiling*) depends on global data, whereas we show that also the *weak zonotopal tilings* considered below are equivalent.

- To proceed from the local data of a weak zonotopal tiling to the global data of a strong zonotopal tiling (Section 3), we utilize a simple geometric construction (Section Lemma 3.2), which also provides most of the geometric information needed for the passage to oriented matroids. (Related constructions appear in [3, Sect. 2.1].)

Finally, we prove that not every oriented matroid is representable by a suitable zonotopal tiling. We construct a rank 4 oriented matroid with 40 elements that cannot be obtained as substructure of a lifting of a realizable oriented matroid.

1. Definitions and Theorems. For the following, we need some oriented matroid terminology (as in [2]), as follows.

The three elements of the set $\{+1, -1, 0\}$, abbreviated by $\{+, -, 0\}$, are referred to as *signs*, while *sign vectors* are elements of $\{+, -, 0\}^{[n]}$ for some $n \geq 0$ and $[n] := \{1, \dots, n\}$. For sign vectors we denote components by X_i , while X^+, X^- and X^0 denote the positive, negative and zero parts of X , with $X^+ = \{i : X_i = +\}$, etc. The *support* of a sign vector is $X^+ \cup X^- = [n] \setminus X^0$. The zero vector is denoted $\mathbf{0}$. There is a partial order on the set of signs defined by “ $0 < +$ ” and “ $0 < -$ ”, while the non-zero signs are incomparable. This partial order is extended to the component-wise partial order of the sign vectors in $\{+, -, 0\}^{[n]}$. We also need the *separation set* $S(X, Y) = \{i : X_i = -Y_i \neq 0\}$, and the *product* $X \circ Y$ of sign vectors, given by $(X \circ Y)_i = Y_i$ if $X_i < Y_i$, and $(X \circ Y)_i = X_i$ otherwise.

For the following let $V = (\mathbf{v}_1, \dots, \mathbf{v}_n) \in \mathbb{R}^{d \times n}$ be a fixed *vector configuration* in \mathbb{R}^d . We assume that the vectors are non-zero, but they need not be distinct, so V is in fact a *multiset* of vectors. The configuration is *simple* if any two vectors are linearly independent from each other, that is, there are no parallel or antiparallel vectors in V . There are two objects defined in terms of V which are closely related: its “zonotope” and its “oriented matroid”.

Definition 1.1. The *zonotope* $Z(V)$ of V is the Minkowski sum of line segments

$$Z(V) := \sum_{i=1}^n [-\mathbf{v}_i, +\mathbf{v}_i] = \left\{ \sum_{i=1}^n \lambda_i \mathbf{v}_i : -1 \leq \lambda_i \leq +1 \right\} \subseteq \mathbb{R}^d.$$

The *oriented matroid* of V is given by its collection of *covectors*:

$$\mathcal{L}(V) := \{(\text{sign}(\mathbf{c} \cdot \mathbf{v}_1), \text{sign}(\mathbf{c} \cdot \mathbf{v}_2), \dots, \text{sign}(\mathbf{c} \cdot \mathbf{v}_n)) : \mathbf{c} \in (\mathbb{R}^d)^*\} \subseteq \{+, -, 0\}^{[n]}$$

While the zonotope $Z(V)$ is a polytope in \mathbb{R}^d , the oriented matroid is a collection of sign vectors. Since we explicitly use the covector axioms for oriented matroids [6] [2, Sects. 3.7 and 4.1] (they abstract the main combinatorial facts about the structure of zonotopes), we repeat them here.

Definition 1.2. [6] [2, 4.1.1] A set $\mathcal{L} \subseteq \{+, -, 0\}^E$ is the set of *covectors* of an *oriented matroid* if and only if it satisfies:

- (L0) $\mathbf{0} \in \mathcal{L}$,
- (L1) $X \in \mathcal{L}$ implies $-X \in \mathcal{L}$,
- (L2) $X, Y \in \mathcal{L}$ implies $X \circ Y \in \mathcal{L}$,
- (L3) if $X, Y \in \mathcal{L}$ and $e \in S(X, Y)$, then there exists $Z \in \mathcal{L}$ such that
 - $Z_e = 0$, and
 - $Z_f = (X \circ Y)_f = (Y \circ X)_f$ for all $f \notin S(X, Y)$.

All the oriented matroids that we deal with are presented in terms of their covectors. Thus, for the following an oriented matroid is a set of sign vectors which satisfies the axioms of Definition 1.2.

For most oriented matroids occurring in the following, the *ground set* E will be either identified with $[n] := \{1, 2, \dots, n\}$, or with $[n] \cup g := \{1, 2, \dots, n, g\}$ in the case where we want to distinguish a special element ‘ g ’.

The *cocircuits* of an oriented matroid \mathcal{L} are the non-zero covectors with maximal zero-set X^0 , that is, with minimal non-empty support $X^+ \cup X^-$. We denote the set of all cocircuits of \mathcal{L} by $\mathcal{C}^* = \mathcal{C}^*(\mathcal{L})$.

We need some constructions to deal with oriented matroids $\mathcal{L} \subseteq \{+, -, 0\}^{[n]}$. The *deletion* $\mathcal{L} \setminus n$ and the *contraction* \mathcal{L} / n of the last element n are defined by

$$\mathcal{L} \setminus n := \left\{ X \in \{+, -, 0\}^{[n-1]} : (X, \sigma) \in \mathcal{L} \text{ for some } \sigma \in \{+, -, 0\} \right\}$$

and

$$\mathcal{L} / n := \left\{ X \in \{+, -, 0\}^{[n-1]} : (X, 0) \in \mathcal{L} \right\}.$$

The element n is a *loop* if $\mathcal{L} = \{(X, 0) : X \in \mathcal{L} / n\}$, and it is a *coloop* if $\mathcal{L} = \{(X, \sigma) : X \in \mathcal{L} / n, \sigma \in \{+, -, 0\}\}$. If n is a loop or coloop, then we have $\mathcal{L} / n = \mathcal{L} \setminus n$, otherwise we have a proper inclusion $\mathcal{L} / n \subset \mathcal{L} \setminus n$. A pair (\mathcal{L}, g) , where \mathcal{L} is an oriented matroid, and g is a distinguished element which is not a loop, is referred to as an *affine oriented matroid* [2, Sects. 4.5 and 10.1].

Two elements of an oriented matroid are *parallel* (resp. *antiparallel*) if they appear with the same sign (resp. with opposite signs) in all the cocircuits. An oriented matroid is *simple* if it has no loop, and no parallel or antiparallel elements. So, a realizable oriented matroid $\mathcal{L}(V)$ is simple if and only if the vectors in V are non-zero and pairwise linearly independent from each other.

The partial order (\mathcal{L}, \leq) is graded, with a unique minimal element $\mathbf{0}$. Its rank is defined to be the *rank* of the oriented matroid \mathcal{L} .

A basic observation is that if $\mathcal{L}' \subseteq \{+, -, 0\}^{[n-1]}$ is an oriented matroid of rank r , and if $\mathcal{L}'' \subseteq \{+, -, 0\}^{[n-1]}$ is an oriented matroid of rank $r-1$ with $\mathcal{L}'' \subseteq \mathcal{L}'$, then there exists an oriented matroid $\mathcal{L} \subseteq \{+, -, 0\}^{[n]}$ which satisfies $\mathcal{L} / n = \mathcal{L}''$ and $\mathcal{L} \setminus n = \mathcal{L}'$. This oriented matroid \mathcal{L} necessarily has rank r , and it is uniquely

determined by \mathcal{L}' and \mathcal{L}'' , except for possible reorientation of the new element n . Furthermore, every oriented matroid \mathcal{L} arises this way, starting from oriented matroids with only loops and coloops.

The recursive characterization of oriented matroids obtained this way combines ideas from Lawrence's original proof [7] of the "Topological Representation Theorem" with Las Vergnas' "Single Element Extension Theorem" [9] [2, Sect. 7.1]. We state and prove it in Theorem 4.1, which also provides tools to recognize the extension \mathcal{L} once the data \mathcal{L}' and \mathcal{L}'' are given. This makes the criterion directly applicable in situations like the Bohne-Dress theorem.

An oriented matroid is *realizable* if it arises from a vector configuration $V \in \mathbb{R}^{d \times n}$ via the construction of Definition 1.1. This is the motivating example for oriented matroids, but there are many other constructions that yield oriented matroids — realizable ones and non-realizable ones.

Given a vector configuration $V \in \mathbb{R}^{d \times n}$ which generates $Z := Z(V)$, we associate a zonotope $Z_X \subseteq Z(V)$ with every sign vector $X \in \{+, -, 0\}^{[n]}$, by

$$Z_X := \sum_{i \in X^0} [-\mathbf{v}_i, +\mathbf{v}_i] + \sum_{i \in X^+} \mathbf{v}_i - \sum_{i \in X^-} \mathbf{v}_i.$$

The assignment $X \mapsto Z_X$ defines an order reversing bijection between the set of covectors of the realizable oriented matroid $\mathcal{L}(V)$ and the set of all non-empty faces of the zonotope $Z(V)$. Thus there is an anti-isomorphism between the face-lattice of $Z(V)$ and the lattice of covectors $\mathcal{L}(V) \cup \hat{1}$ [2, Prop. 2.2.2]. In fact, the maximal elements of \mathcal{L} correspond to the vertices of $Z(V)$, while the cocircuits in \mathcal{L} correspond to the facets of $Z(V)$. (The zero vector $\mathbf{0} \in \mathcal{L}$ corresponds to the zonotope itself, and the additional maximal element $\hat{1}$ corresponds to the empty face.)

The Bohne-Dress Theorem states that the one-element liftings of $\mathcal{L}(V)$ are in one-to-one correspondence to the zonotopal tilings of $Z(V)$. To make this precise, we now define tilings (in two versions) and liftings.

Definition 1.3 [3, Def. 1.3]. Let $V = (\mathbf{v}_1, \dots, \mathbf{v}_n) \in \mathbb{R}^{d \times n}$ be a vector configuration. A *strong zonotopal tiling* (SZT) of $Z(V)$ is a collection of sign vectors $\mathcal{O} \subseteq \{0, +, -\}^{[n]}$ such that

- (i) $\bigcup_{X \in \mathcal{O}} Z_X = Z(V)$
- (ii) If $X \in \mathcal{O}$, and $Y \geq X$ describes a face Z_Y of Z_X , then $Y \in \mathcal{O}$.
- (iii) If $X, Y \in \mathcal{O}$, then $Z_X \cap Z_Y$ is a face of both Z_X and Z_Y .

The strong zonotopal tiling is *simple* if there are no zero or parallel vectors in V , that is, if $\{\mathbf{v}_i, \mathbf{v}_j\}$ is linearly independent for $i \neq j$.

The zonotopes Z_X of maximal dimension (i.e., of dimension d) in a SZT are exactly those for which the support of X is minimal, and thus X^0 is maximal, with respect to set inclusion.

Definition 1.4. Let Z be a zonotope. A *weak zonotopal tiling* (WZT) of Z is a collection of zonotopes $\mathcal{Z} := \{Z_1, Z_2, \dots, Z_M\}$, such that

- (i) $\bigcup_{i=1}^M Z_i = Z$
- (ii) If U is a face of $Z_i \in \mathcal{Z}$, then $U \in \mathcal{Z}$
- (iii) If $Z_i, Z_j \in \mathcal{Z}$, then the intersection $Z_i \cap Z_j$ is a face of both Z_i and Z_j .

The weak zonotopal tiling is *simple* if every edge of Z is in \mathcal{Z} .

The difference between the two definitions is that the first one refers explicitly to the labeled vector data of the underlying zonotope, while the second one characterizes the geometric structure obtained by deleting the information on the labels. Clearly every strong zonotopal tiling determines a weak zonotopal tiling. Furthermore, conditions (ii) and (iii) for a WZT just state that \mathcal{Z} is a polytopal complex.

Definition 1.5. Let $\mathcal{L} \subseteq \{+, -, 0\}^{[n]}$ be an oriented matroid.

A (*one-element*) *lifting* of \mathcal{L} is an oriented matroid $\widehat{\mathcal{L}} \subseteq \{+, -, 0\}^{[n] \cup g}$, such that $\widehat{\mathcal{L}}/g = \mathcal{L}$, and such that g is not a loop in $\widehat{\mathcal{L}}$. We define

$$\mathcal{O}(\widehat{\mathcal{L}}) := \{X \in \{0, +, -\}^{[n]} : (X, +) \in \widehat{\mathcal{L}}\}.$$

Our main result appears below as Theorem 1.7. Corollary 1.8 isolates an important special case. To formulate these results, we use the following method to (re)construct the zones in a weak zonotopal tiling, and a basic property observed in Lemma 1.6.

In a weak zonotopal tiling \mathcal{Z} , define two edges (1-dimensional faces of the tiling) to be *related* if they are opposite in a 2-face of \mathcal{Z} . Denote by $\mathcal{E}_1, \dots, \mathcal{E}_n$ the equivalence classes generated by this relation. *Equivalent* edges (i.e., edges in the same equivalence class) are always parallel, but the converse is false — see the sketch below, where the vertical edges fall into two equivalence classes, the bold ones and the regular ones. We will denote by $\mathcal{Z}_1, \dots, \mathcal{Z}_n$ the *zones* of the WZT, where \mathcal{Z}_i is the set of all faces of \mathcal{Z} which have an edge in \mathcal{E}_i .

The following sketch shows (bold) the edges in one class \mathcal{E}_i and the corresponding zone, which consists of the bold edges together with the shaded 2-faces.

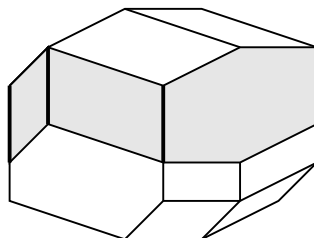

Lemma 1.6. Let \mathcal{Z} be a weak zonotopal tiling of $Z \subseteq \mathbb{R}^d$, let $\mathcal{E}_1, \dots, \mathcal{E}_n$ be the equivalence classes of edges in \mathcal{Z} , and let $V = \{\mathbf{v}_1, \dots, \mathbf{v}_n\} \in \mathbb{R}^{d \times n}$ be a vector configuration such that the edges in \mathcal{E}_i are translates of $[-\mathbf{v}_i, \mathbf{v}_i]$, for $1 \leq i \leq n$. Then the zonotope Z is generated by the vectors in V , that is, $Z = Z(V)$.

Lemma 1.6 will be proved in Theorem 3.3. The vector configuration described by it will be denoted by $V = V(\mathcal{Z})$. This *vector configuration associated with \mathcal{Z}* is unique up to taking negatives of the vectors. Note that $V(\mathcal{Z})$ is a multiset: there may be repeated vectors, parallel and antiparallel ones.

The associated vector configuration is simple if and only if the WZT is simple. In this case (for example, if \mathcal{Z} is just the face complex of Z) the associated configuration is the simple vector configuration that defines Z . From it, we get all the non-simple configurations that generate the zonotope Z by replacing each \mathbf{v}_i by a sequence of vectors $\alpha_1 \mathbf{v}_i, \dots, \alpha_{k(i)} \mathbf{v}_i$ with $\alpha_i \in \mathbb{R} \setminus 0$ and $\sum_{j=1}^{k(i)} |\alpha_j| = 1$. Together

with our main theorem this yields a description of all the weak zonotopal tiling of a given zonotope Z .

Theorem 1.7. *Let $V \in \mathbb{R}^{d,n}$ be a vector configuration, let $Z := Z(V)$ be its zonotope and $\mathcal{L} := \mathcal{L}(V)$ its oriented matroid. Then there are canonical bijections between*

- the weak zonotopal tilings \mathcal{Z} of Z with associated vector configuration V ,
- the strong zonotopal tilings $\mathcal{O} \subseteq \{+, -, 0\}^{[n]}$ of $Z(V)$, and
- the oriented matroid liftings $\widehat{\mathcal{L}} \subseteq \{+, -, 0\}^{[n] \cup g}$ of $\mathcal{L}/g = \mathcal{L}$.

As a direct consequence, we get the following version of Theorem 1.7 for the case of simple zonotopal tilings.

Corollary 1.8. *Let $Z \subseteq \mathbb{R}^d$ be a zonotope with n zones, let $V = V(Z) \in \mathbb{R}^{d,n}$ be its (essentially unique) simple vector configuration, and let $\mathcal{L} = \mathcal{L}(V)$ be the associated simple oriented matroid. Then there are canonical bijections between*

- the simple weak zonotopal tilings $\mathcal{Z} = \{Z_1, Z_2, \dots\}$ of Z ,
- the simple strong zonotopal tilings $\mathcal{O} \subseteq \{+, -, 0\}^{[n]}$ of $Z(V)$, and
- the single element liftings $\widehat{\mathcal{L}}$ of the oriented matroid $\mathcal{L}(V)$.

A complete proof of Theorem 1.7 appears in the following three sections. The specialization to the ‘simple’ case is immediate at each step, so Corollary 1.8 follows as a by-product. The proof for Lemma 1.6 will be a part of Section 3.

The Bohne-Dress theorem, in the version of [3, Thms. 4.1 and 4.2], is the equivalence of strong zonotopal tilings with oriented matroid liftings. Our notion of strong zonotopal tilings is easily seen to be equivalent with the “zonotopale Pflasterungen” of [3, Def. 1.3]. The purely polytopal formulation of weak zonotopal tilings is not considered in [3]

2. From Liftings to Tilings. Now we prove the following part of Theorem 1.7.

Theorem 2.1 [3, Thm. 4.2]. *Let $V \in \mathbb{R}^{d,n}$ be a vector configuration of rank d , and let $\widehat{\mathcal{L}} \subseteq \{+, -, 0\}^{[n] \cup g}$ be a lifting of the oriented matroid $\mathcal{L}(V)$. Then $\mathcal{O}(\widehat{\mathcal{L}})$ is a strong zonotopal tiling of $Z(V)$.*

Before presenting the proof of Theorem 2.1 we first prove some lemmas.

Lemma 2.2. *For any vector configuration V we have*

$$\text{vol}(Z(V)) = \sum_{(X,+)\in\mathcal{C}^*} \text{vol}(Z_X),$$

where $\mathcal{C}^* = \mathcal{C}^*(\widehat{\mathcal{L}})$ is the set of cocircuits of a one-element lifting of the oriented matroid $\mathcal{L}(V)$.

Proof. For a linearly ordered set E , we define

$$\Lambda(E, d) := \{(\lambda_1, \dots, \lambda_d) \in E^d : \lambda_1 < \dots < \lambda_d\}.$$

By a result of McMullen, see [16] [2, Prop. 2.2.12], the volume of a d -dimensional zonotope $Z(\mathbf{v}_1, \dots, \mathbf{v}_n)$ is given by

$$\text{vol}(Z(\mathbf{v}_1, \dots, \mathbf{v}_n)) = 2^d \cdot \sum_{\lambda \in \Lambda(E, d)} |\det(\mathbf{v}_{\lambda_1}, \dots, \mathbf{v}_{\lambda_d})|.$$

Notice that by this formula for a zonotope $Z_X, X \in \{+, -, 0\}^d$, we obtain

$$\text{vol}(Z_X) = 2^d \cdot \sum_{\lambda \in \Lambda(X^0, d)} |\det(\mathbf{v}_{\lambda_1}, \dots, \mathbf{v}_{\lambda_d})|$$

and thus

$$\begin{aligned} \sum_{(X,+) \in \mathcal{C}^*} \text{vol}(Z_X) &= \sum_{(X,+) \in \mathcal{C}^*} (2^d \cdot \sum_{\lambda \in \Lambda(X^0, d)} |\det(\mathbf{v}_{\lambda_1}, \dots, \mathbf{v}_{\lambda_d})|) \\ &= \sum_{(X,+) \in \mathcal{C}^*} (2^d \cdot \sum_{\substack{\lambda \in \Lambda(X^0, d) \\ \lambda \text{ independent in } \widehat{\mathcal{L}}/g}} |\det(\mathbf{v}_{\lambda_1}, \dots, \mathbf{v}_{\lambda_d})|) \\ &= 2^d \cdot \sum_{\substack{\lambda \in \Lambda(E, d) \\ \lambda \text{ independent in } \widehat{\mathcal{L}}/g}} |\det(\mathbf{v}_{\lambda_1}, \dots, \mathbf{v}_{\lambda_d})| \\ &= 2^d \cdot \sum_{\lambda \in \Lambda(E, d)} |\det(\mathbf{v}_{\lambda_1}, \dots, \mathbf{v}_{\lambda_d})| \\ &= \text{vol}(Z(V)). \end{aligned}$$

The second and the fourth equality hold since only independent sets of vectors have non-zero determinants. The third equation holds since every maximal independent set (every basis) of $\widehat{\mathcal{L}}/g$ is contained in the zero set of a unique cocircuit $(X, +)$ of $\widehat{\mathcal{L}}$. \square

The core of this proof is the volume formula for zonotopes, which says that if we take any zonotopal tiling and refine it to a tiling by parallelotopes, then the set of tiles is unique (up to translation of the tiles): we get exactly one full-dimensional tile for every independent set of zones of the zonotope (i.e., for every basis of the oriented matroid $\mathcal{L}(V)$) — see [16, Sect. 5].

Thus the total volume of the set of zonotopal tiles $Z_X, X \in \mathcal{O}(\widehat{\mathcal{L}})$, equals the volume of $Z(V)$. Our next lemma shows that the intersection of any two such tiles has zero volume, so the union of the tiles covers $Z(V)$.

Lemma 2.3. *Let $X, Y \in \mathcal{O}(\widehat{\mathcal{L}})$ be two sign vectors.*

- (i) $S(X, Y) \neq \emptyset \implies Z_X \cap Z_Y = \emptyset$,
- (ii) $S(X, Y) = \emptyset \implies Z_X \cap Z_Y = Z_{X \circ Y} = Z_{Y \circ X}$.

Proof. By definition $(X, +)$ and $(Y, +)$ are covectors of $\widehat{\mathcal{L}}$. We abbreviate $A^{ij} = X^i \cap Y^j$ for $i, j \in \{+, -, 0\}$. Without loss of generality we may (up to reorientation of the vectors \mathbf{v}_i) assume that $A^{-0} = A^{0+} = A^{-+} = A^{-+} = \emptyset$. With this conventions we can write

$$\begin{aligned} Z_X &= \sum_{i \in A^{00} \sqcup A^{0-}} [-\mathbf{v}_i, \mathbf{v}_i] + \sum_{i \in A^{+0} \sqcup A^{+-}} \mathbf{v}_i + \sum_{i \in A^{++}} \mathbf{v}_i, \\ Z_Y &= \sum_{i \in A^{00} \sqcup A^{+0}} [-\mathbf{v}_i, \mathbf{v}_i] - \sum_{i \in A^{0-} \sqcup A^{+-}} \mathbf{v}_i + \sum_{i \in A^{++}} \mathbf{v}_i. \end{aligned}$$

The components of A^{++} generate an identical translational component for all three Z_X, Z_Y and $Z_{X \circ Y}$. Thus, if we are interested in the intersection of Z_X and Z_Y

we may also without loss of generality assume that $A^{++} = \emptyset$. We define $\widehat{X} = (X, +) \circ (-Y, -) \in \widehat{\mathcal{L}}$ and $\widehat{Y} = (-Y, -) \circ (X, +) \in \widehat{\mathcal{L}}$. Observe that

$$\widehat{X}^+ = A^{+0} \uplus A^{+-} \uplus A^{0-} \uplus \{g\}, \quad \widehat{X}^- = \emptyset, \quad \widehat{X}^0 = A^{00}$$

and

$$\widehat{Y}^+ = A^{+0} \uplus A^{+-} \uplus A^{0-}, \quad \widehat{Y}^- = \{g\}, \quad \widehat{Y}^0 = A^{00}.$$

The separation set of \widehat{X} and \widehat{Y} is $S(\widehat{X}, \widehat{Y}) = \{g\}$. Applying the elimination axiom for covectors (Definition 1.2(L3)) to the covectors \widehat{X} and \widehat{Y} we obtain that there exists a covector $W \in \widehat{\mathcal{L}}$ with

$$W^0 = A^{00} \uplus \{g\}, \quad W^+ = A^{+0} \uplus A^{+-} \uplus A^{0-}, \quad W^- = \emptyset.$$

This implies the existence of a covector $W' \in \widehat{\mathcal{L}}/g$ with

$$W'^0 = A^{00}, \quad W'^+ = A^{+0} \uplus A^{+-} \uplus A^{0-}, \quad W'^- = \emptyset.$$

Therefore there must be a linear functional $\mathbf{a} \in (\mathbb{R}^d)^*$ with

$$\text{sign}(\mathbf{a} \cdot \mathbf{v}_i) = \begin{cases} 0 & \text{if } i \in A^{00}, \\ + & \text{if } i \in A^{+0} \uplus A^{+-} \uplus A^{0-}. \end{cases}$$

Now consider the affine functional $H_{\mathbf{a}}(\mathbf{x}) = \mathbf{a} \cdot (\mathbf{x} - \sum_{i \in A^{+0}} \mathbf{v}_i + \sum_{i \in A^{0-}} \mathbf{v}_i)$. We will prove that the hyperplane $H := \{\mathbf{x} \in \mathbb{R}^d : H_{\mathbf{a}}(\mathbf{x}) = 0\}$ separates the two zonotopes Z_X and Z_Y . In fact,

$$\begin{aligned} H_{\mathbf{a}}(Z_X) &= \\ &= \mathbf{a} \cdot \left(\sum_{i \in A^{00}} [-\mathbf{v}_i, +\mathbf{v}_i] + \sum_{i \in A^{0-}} [-\mathbf{v}_i, +\mathbf{v}_i] + \right. \\ &\quad \left. + \sum_{i \in A^{+-}} \mathbf{v}_i + \sum_{i \in A^{+0}} \mathbf{v}_i - \sum_{i \in A^{+0}} \mathbf{v}_i + \sum_{i \in A^{0-}} \mathbf{v}_i \right) \\ &= (\mathbf{a} \cdot \sum_{i \in A^{00}} [-\mathbf{v}_i, +\mathbf{v}_i]) + (\mathbf{a} \cdot \sum_{i \in A^{0-}} [0, +2\mathbf{v}_i]) + (\mathbf{a} \cdot \sum_{i \in A^{+-}} \mathbf{v}_i) \\ &= [0, 2 \cdot \sum_{i \in A^{0-}} (\mathbf{a} \cdot \mathbf{v}_i)] + \sum_{i \in A^{+-}} (\mathbf{a} \cdot \mathbf{v}_i). \end{aligned}$$

The first of the two remaining summands is an interval $[0, b_X]$ with $b_X > 0$ whenever $A^{0-} \neq \emptyset$ and $b_X = 0$ otherwise. The second summand is a scalar c with $c > 0$ whenever $A^{+-} \neq \emptyset$ and $c = 0$ otherwise. A completely similar calculation shows that $H_{\mathbf{a}}(Z_Y)$ is of the form

$$H_{\mathbf{a}}(Z_Y) = [-b_Y, 0] - c$$

with $b_Y > 0$ whenever $A^{+0} \neq \emptyset$ and $b_Y = 0$ otherwise.

If we consider the case $S(X, Y) = A^{+-} \neq \emptyset$ we see that $H_{\mathbf{a}}(Z_X)$ and $H_{\mathbf{a}}(Z_Y)$ are non-overlapping intervals. Therefore $Z_X \cap Z_Y = \emptyset$, which proves part (i) of the lemma. In the case $S(X, Y) = A^{+-} = \emptyset$ we see that

$$H \cap Z_X = \sum_{i \in A^{00}} [-\mathbf{v}_i, +\mathbf{v}_i] + \sum_{i \in A^{+0}} \mathbf{v}_i - \sum_{i \in A^{0-}} \mathbf{v}_i = H \cap Z_Y.$$

On the other hand the relative interiors of Z_X and Z_Y are separated by H . Therefore

$$Z_X \cap Z_Y = \sum_{i \in A^{00}} [-\mathbf{v}_i, +\mathbf{v}_i] + \sum_{i \in A^{+0}} \mathbf{v}_i - \sum_{i \in A^{0-}} \mathbf{v}_i = Z_{X \circ Y} = Z_{Y \circ X}.$$

This proves part (ii) of the lemma. \square

The following picture illustrates the situation for a tiling on 4 zones and sign vectors $X = (+0+0)$ and $Y = (0-0-)$. The left figure shows how the hyperplane $H_{\mathbf{a}}$ separates the zonotopes Z_X and Z_Y . The right figure shows the relative position of the translated hyperplane $H'_{\mathbf{a}} := \{\mathbf{x} \in \mathbb{R}^d : \mathbf{a} \cdot \mathbf{x} = 0\}$ with respect to $\mathbf{v}_1, \dots, \mathbf{v}_4$. Notice that, since in this case A^{+-} is empty, the two zones have a face in common.

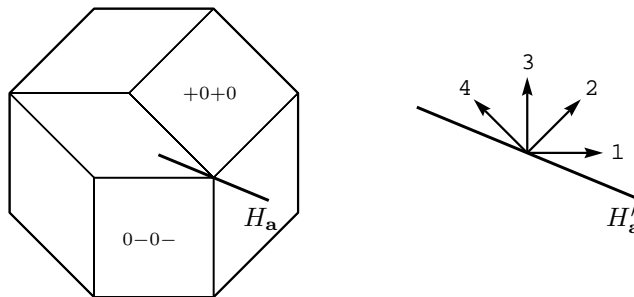

Before proving the main theorem we provide a lemma which states that the set of zonotopes associated to $\mathcal{O}(\widehat{\mathcal{L}})$ is closed under the operation of taking faces of zonotopes.

Lemma 2.4. *Let Z_X be a zonotope with $X \in \mathcal{O}(\widehat{\mathcal{L}})$ and let Z_Y be a face of Z_X , with $Y \geq X$. Then $Y \in \mathcal{O}(\widehat{\mathcal{L}})$.*

Proof. For every covector $(X, +) \in \widehat{\mathcal{L}}$ there is also a cocircuit $(\widehat{X}, +) \in \widehat{\mathcal{L}}$ with $(\widehat{X}, +) \leq (X, +)$. Therefore every zonotope Z_X with $(X, +) \in \widehat{\mathcal{L}}$ is contained as a face in a zonotope $Z_{\widehat{X}}$ of maximal dimension and it suffices to prove the lemma for the case where $(X, +)$ is a cocircuit.

Let Z_Y be a face of the zonotope Z_X where $(X, +)$ is a cocircuit. We may assume that $X^0 = \{1, 2, \dots, k\}$ for some $k \leq n$. Notice that the face lattice of

$$Z_X = \sum_{i \in X^0} [-\mathbf{v}_i, +\mathbf{v}_i] + \sum_{i \in X^+} \mathbf{v}_i - \sum_{i \in X^-} \mathbf{v}_i$$

is isomorphic to the face lattice of the translated zonotope:

$$Z' = Z(\mathbf{v}_1, \mathbf{v}_2, \dots, \mathbf{v}_k) = \sum_{i \in X^0} [-\mathbf{v}_i, +\mathbf{v}_i]$$

Assume that Z_Y with $Y \geq X$ is a face of Z_X then $Z_{Y'}$ with $Y' := (Y_1, Y_2, \dots, Y_k)$ is a face of Z' . By Theorem 1.3 the faces of Z' have the form Z_W where W are the covectors of

$$\widehat{\mathcal{L}}' := (\widehat{\mathcal{L}}/g) \setminus \{k+1, \dots, n\}.$$

Hence Y' is a covector of $\widehat{\mathcal{L}}'$. Therefore there exist signs $\sigma_{k+1}, \sigma_{k+2}, \dots, \sigma_n$ such that

$$Y'' := (Y'_1, Y'_2, \dots, Y'_k, \sigma_{k+1}, \sigma_{k+2}, \dots, \sigma_n, 0)$$

is a covector of $\widehat{\mathcal{L}}$. Hence $Y = X \circ Y''$ is also a covector of $\widehat{\mathcal{L}}$. \square

Now we have collected all the pieces to prove Theorem 2.1.

Proof of Theorem 2.1. We have to prove that the collection of sign vectors

$$\mathcal{O}(\widehat{\mathcal{L}}) := \{X \in \{0, +, -\}^{[n]} : (X, +) \in \widehat{\mathcal{L}}\}$$

is a strong zonotopal tiling of $Z(V)$, i.e., it satisfies the three conditions of Definition 1.3. Condition (ii) is exactly the statement of Lemma 2.4. Lemma 2.3 states that the intersection of Z_X and Z_Y is either empty or of the form $Z_{X \circ Y}$. This proves condition (iii) of Definition 1.4, since $(X, +), (Y, +) \in \widehat{\mathcal{L}}$ implies $(X \circ Y, +) \in \widehat{\mathcal{L}}$. To prove condition (i),

$$\bigcup_{X \in \mathcal{O}(\widehat{\mathcal{L}})} Z_X = Z(V),$$

observe that by Lemma 2.2 the total volume of all Z_X , where $(X, +)$ is a cocircuit of $\widehat{\mathcal{L}}$, equals the volume of $Z(V)$. On the other hand, by Lemma 2.3 the volume of $Z_X \cap Z_Y$ is zero for any two distinct cocircuits $(X, +)$ and $(Y, +)$. Therefore the union of all Z_X must cover $Z(V)$, since we have $Z_X \subseteq Z(V)$ for all $X \in \mathcal{O}$. \square

3. From Weak Tilings to Strong Tilings. It is a classical fact that a polytope all of whose faces are centrally symmetric is a zonotope. We need the following criterion. (See also [2, Prop. 2.2.14].)

Lemma 3.1. *A polytope P is a zonotope if and only if every face of P is a Minkowski summand of P .*

The following crucial lemma implies that the zones in a WZT have the geometric structure that “one would expect” from the drawings: they form one thick sheet which projects down “without folding” if we project in the direction of the edges in the zone.

Lemma 3.2 (“Section Lemma”). *Let \mathcal{Z} be a WZT of $Z := \bigcup \mathcal{Z} \subseteq \mathbb{R}^d$, let \mathcal{E}_i be an equivalence class of edges in \mathcal{Z} , all of them translates of $[-\mathbf{v}_i, \mathbf{v}_i] \subseteq \mathbb{R}^d$, and let $\mathcal{Z}_i \subseteq \mathcal{Z}$ denote the corresponding zone.*

Denote by $\pi_i(Z)$ the projection of Z in direction \mathbf{v}_i , that is,

$$\pi_i(Z) := \{\mathbf{x} \in \mathbb{R}^d : \langle \mathbf{x}, \mathbf{v}_i \rangle = 0, \exists t \in \mathbb{R} : \mathbf{x} + t\mathbf{v}_i \in Z\}.$$

Then the function $f_i : \pi_i(Z) \rightarrow \mathbb{R}$

$$\mathbf{x} \mapsto \min \{t \in \mathbb{R} : \mathbf{x} + t\mathbf{v}_i \in \bigcup \mathcal{Z}_i\}$$

is well-defined, continuous and piecewise linear.

Proof. The function f_i is clearly well-defined on the set $\pi_i(\bigcup \mathcal{Z}_i) \subseteq \pi_i(Z)$, which is non-empty and closed by construction. Furthermore, if $\mathbf{x}_0 \in \pi_i(\bigcup \mathcal{Z}_i)$, then

$$F_i(\mathbf{x}_0) := \mathbf{x}_0 + (f_i(\mathbf{x}_0) + 1)\mathbf{v}_i$$

is in the relative interior of some face U of Z_i .

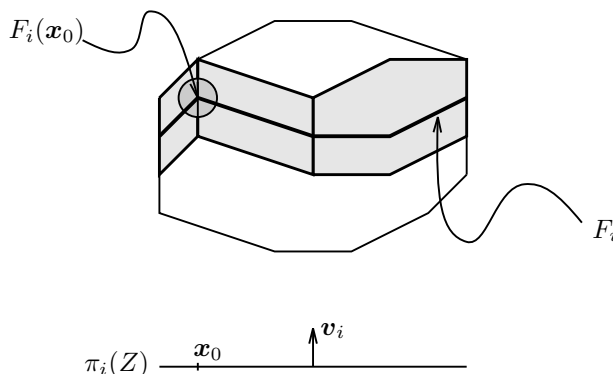

Hence

$$Z \cap (F_i(x_0) + \epsilon B^d) \subseteq \bigcup Z_i$$

for small enough $\epsilon > 0$, since with U the zone Z_i also contains the *star* of U : all the polytopes of \mathcal{Z} that have U as a face. From this we see that $\pi(\bigcup Z_i)$ is open in $\pi_i(Z)$. Since it is also closed, we conclude $\pi_i(\bigcup Z_i) = \pi_i(Z)$, and thus f_i is well-defined on $\pi_i(Z)$.

To see that f_i (and thus F_i) is continuous, observe that in a small neighborhood of x_0 the function f_i is the “height” of the “lower faces” in the star of U .

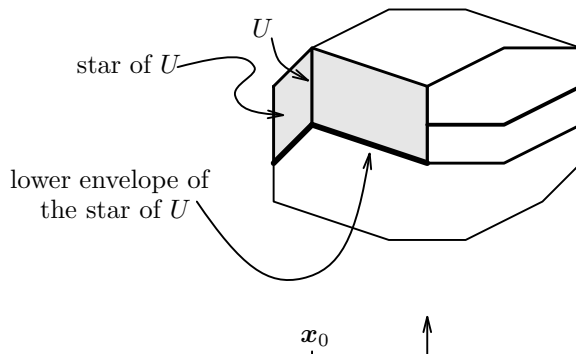

The lower faces determine a piecewise linear and continuous “lower height” function on $\pi(W)$, for every face W in the zone. Since the “lower height” functions agree on intersections of faces, we get that “the lower height of the faces that contain U ” defines a continuous (and piecewise linear) function on $\pi(\text{star}(U))$, and thus in a neighborhood of x_0 .

Now the lower height function of the star of U agrees with f_i in a neighborhood of x_0 : in fact, f_i could only be lower if there was a different polyhedron G in Z_i whose lower height was smaller. However, since f_i is not smaller than the lower height of the star of U at x_0 , the lower height function agrees with f_i also in a neighborhood of x_0 . \square

The following statement provides the implication “every weak zonotopal tiling corresponds to a strong zonotopal tiling” of the Main Theorem 1.7. It also includes Lemma 1.6.

Theorem 3.3. *Let \mathcal{Z} be a weak zonotopal tiling of a zonotope Z with center $\mathbf{0}$. Let $\mathcal{E}_1, \dots, \mathcal{E}_n$ be the equivalence classes of edges, where the edges in \mathcal{E}_i are translates of $[-\mathbf{v}_i, \mathbf{v}_i]$, and let the corresponding zones be $\mathcal{Z}_1, \dots, \mathcal{Z}_n$. Then there is an assignment of signs*

$$\sigma : \mathcal{Z} \longrightarrow \{+, -, 0\}$$

such that

- $\sigma(U)_i = 0$ if and only if $U \in \mathcal{Z}_i$, and
- $\sigma(\mathbf{x}')_i = -$ and $\sigma(\mathbf{x}'')_i = +$, if the edge $[\mathbf{x}', \mathbf{x}'']$ is in \mathcal{E}_i , and
- $U \subseteq U'$ if and only if $\sigma(U) \geq \sigma(U')$.

Furthermore, the zonotope $Z = \bigcup \mathcal{Z}$ is the Minkowski sum $\sum_{i=1}^n [-\mathbf{v}_i, \mathbf{v}_i]$, and

$$\mathcal{O} := \{\sigma(P) : P \in \mathcal{Z}\}$$

is a strong polytopal tiling of Z whose underlying weak zonotopal tiling is \mathcal{Z} .

Our drawing shows the sign vectors that correspond to the maximal faces of \mathcal{Z} , in the WZT that we considered in Section 0. Exercise: determine (some of) the sign vectors corresponding to the vertices in this drawing.

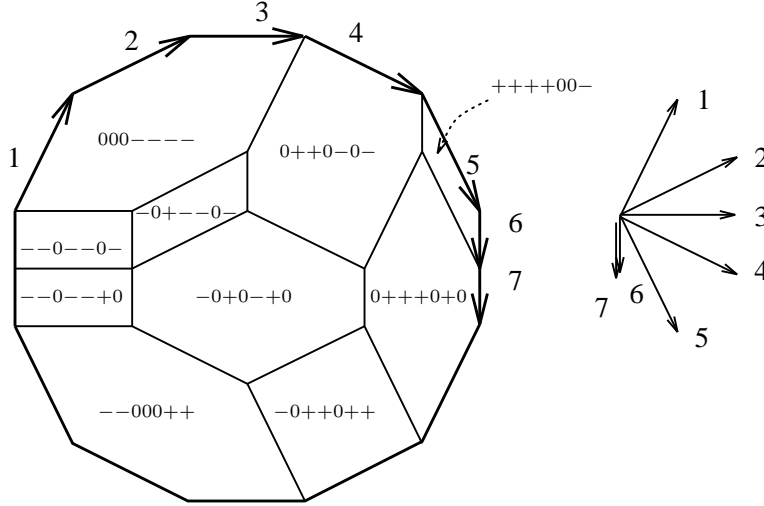

Proof. Consider the i -th component of such a σ -function. The first condition is that it vanishes on the zone, and the second condition says that it has opposite values on the two ends of an edge in \mathcal{E}_i , “+” on the top end, and “-” on the lower end. With this, the first and the third condition imply that σ_i is constant “+” above the zone, and constant “-” below it. This is well-defined and unique by Lemma 3.2, according to which the i -th zone separates the WZT into the zone, the faces ‘above’ it and the faces ‘below’ it.

The assignment of signs satisfying all three conditions implies that we have

$$U = Z_{\sigma(U)} + \mathbf{z}_0 \quad \text{for } U \in \mathcal{Z},$$

where \mathbf{z}_0 is some translation vector: the same one for all the zonotopes in \mathcal{Z} . Now the facts that opposite vertices of Z get opposite signs under σ , and that Z is centrally symmetric with respect to the origin $\mathbf{0}$, together imply $\mathbf{z}_0 = \mathbf{0}$. \square

The strong zonotopal tilings we produce with this method of labeling have a special property: they use the minimal number n of components; equivalently, for every edge $U \in \mathcal{Z}$, the sign vector $\sigma(U)$ will have only one 0-component. To obtain an arbitrary SZT for a given WZT \mathcal{Z} , one can reverse the sign on any single component of σ , and add new components that are multiples of given ones. In the following section, we will see that this exactly corresponds to reorientation and to the introduction of parallel elements, and loops, into the oriented matroid associated with the situation.

4. From Strong Tilings to Liftings. The remaining part of the Bohne-Dress Theorem is the fact that the family \mathcal{O} constructed in Theorem 3.3 actually corresponds to an oriented matroid. There are various different ways to establish that.

- (1) A direct method would be to verify that \mathcal{O} itself is an *affine oriented matroid*, as studied and axiomatized by Karlander [8].
- (2) One could modify the functions $F_i(\mathbf{x})$ of the Section Lemma 3.2 so that the graph becomes a subcomplex of the barycentric subdivision of the WZT. Then the set of graphs yields a topological realization of the affine oriented matroid \mathcal{O} . (The graphs of these functions intersect like affine pseudohyperplanes; a complete topological realization of all of $\mathcal{L}(\mathcal{O})$ can be constructed in the boundary of the prism $Z(V) \times I$.) Thus, one could verify the axioms for pseudoarrangements.
- (3) Alternatively, one can verify a set of covector axioms for the associated full oriented matroid, i.e., prove the Theorem 4.3 below by direct verification of axioms. This becomes feasible (using induction on the number of elements) if one uses that every tiling can be built up from two smaller ones, obtained by *shrinking* and *projection* of a zone, corresponding to *deletion* resp. *contraction* of an element in the oriented matroid. This is what Bohne did in his dissertation [3].
- (4) In our treatment, we also rely on deletion and contraction to proceed by induction. The fact that these two operations work properly relies on crucial facts about the geometry of a zone, as isolated by the Section Lemma 3.2. However, instead of verifying the covector axioms, we apply a very powerful criterion (Theorem 4.1). Loosely, it states that a given structure represents an oriented matroid if it properly combines its deletion and its contraction, and those are oriented matroids.

Theorem 4.1. *Let $\mathcal{L}', \mathcal{L}'' \subseteq \{+, -, 0\}^{[n-1]}$ be two oriented matroids, of rank r respectively of rank $r - 1$, such that $\mathcal{L}'' \subseteq \mathcal{L}'$.*

- (1) *There is an oriented matroid $\mathcal{L} \subseteq \{+, -, 0\}^{[n]}$ such that $\mathcal{L} \setminus n = \mathcal{L}'$ and $\mathcal{L}/n = \mathcal{L}''$.*

The oriented matroid \mathcal{L} has rank r . It is unique up to reorientation of the element n .

- (2) *Given the oriented matroid $\mathcal{L} \subseteq \{+, -, 0\}^{[n]}$ of rank r extending \mathcal{L}' with $\mathcal{L}/n = \mathcal{L}''$, there is a unique function*

$$\sigma : \mathcal{C}^*(\mathcal{L}') \longrightarrow \{+, -, 0\}$$

satisfying

$$(X, \sigma(X)) \in \mathcal{L} \quad \text{for all } X \in \mathcal{C}^*(\mathcal{L}'),$$

known as the localization of the extension \mathcal{L} of \mathcal{L}' .

In terms of \mathcal{L}' , \mathcal{L}'' and the localization σ , the oriented matroid \mathcal{L} is given by

$$\begin{aligned} \mathcal{L} = & \{(X, 0): X \in \mathcal{L}''\} \\ & \cup \{(X, +): X \in \mathcal{L}', \text{ and } X \geq Y \text{ for some } Y \in \mathcal{C}^*(\mathcal{L}') \text{ with } \sigma(Y) = +\} \\ & \cup \{(X, -): X \in \mathcal{L}', \text{ and } X \geq Y \text{ for some } Y \in \mathcal{C}^*(\mathcal{L}') \text{ with } \sigma(Y) = -\} \end{aligned}$$

(3) The localization σ of (2) is determined, uniquely up to a global sign, by the following three properties:

- (i) $\sigma(-X) = -\sigma(X)$ for all $X \in \mathcal{C}^*(\mathcal{L}')$, [antisymmetry]
- (ii) $\sigma(X) = 0$ if and only if $X \in \mathcal{L}''$, [localization]
- (iii) $\sigma(X^1) = \sigma(X^2)$
if $X^1, X^2 \in \mathcal{C}^*(\mathcal{L}')$ are adjacent, and if no $X \in \mathcal{C}^*(\mathcal{L}'')$ satisfies $X \leq X^1 \circ X^2$, i.e., if X^1 and X^2 are connected by an edge $X^1 \circ X^2 = X^2 \circ X^1$ in the pseudoarrangement representing \mathcal{L}' , and the subsphere \mathcal{L}'' does not meet this edge.

Proof. (1) According to the Topological Representation Theorem (see [2, Chaps. 4 and 5]), the order complex $\Delta(\mathcal{L}' \setminus \mathbf{0})$ is a $(r-1)$ -sphere: the barycentric subdivision of the “usual” representation of the oriented matroid \mathcal{L} by a sphere arrangement (i.e., a regular cell complex $\Gamma(\mathcal{L}')$ whose face poset is \mathcal{L}'). Similarly, the complex $\Delta(\mathcal{L}'' \setminus \mathbf{0})$ is a simplicial $(r-2)$ -sphere.

The inclusion $\mathcal{L}'' \subseteq \mathcal{L}'$ implies that $S_n := \Delta(\mathcal{L}'' \setminus \mathbf{0})$ is a simplicial subcomplex of $\Delta(\mathcal{L}' \setminus \mathbf{0})$. Thus we get an embedding $S^{r-2} \hookrightarrow S_n \subseteq S^{r-1}$. At this point, we choose one of the two hemispheres in S^{r-1} , and call it the *positive side* of the embedded $(r-2)$ -subsphere S_n .

From this it is not at all clear that the embedding is tame, and that the complex $\Delta(\mathcal{L}')$ together with the embedded sphere S_n represent an oriented matroid \mathcal{L} on n elements. However, we can use the embedded sphere S_n to distinguish the vertices of $\Gamma(\mathcal{L}')$ which lie on S_n , on the positive side of S_n , and on the negative side of S_n . Thus we get a localization function $\sigma: \mathcal{C}^*(\mathcal{L}') \rightarrow \{0, +, -\}$ from the topological embedding.

For every rank 2 contraction \mathcal{L}'/A of the oriented matroid \mathcal{L}' , the corresponding contraction $\mathcal{L}''/A \subseteq \mathcal{L}'/A$ has rank 1 or 2. Thus the function σ defines a valid extension of \mathcal{L}'/A by a regular element resp. by a loop. From this, the Single Element Extension Theorem of Las Vergnas [9] [2, Thm. 7.1.8(ii)] guarantees the existence of a unique extension \mathcal{L} .

The oriented matroid \mathcal{L} satisfies the first condition $\mathcal{L} \setminus n = \mathcal{L}'$ by construction, while the condition $\mathcal{L}/n = \mathcal{L}''$ follows by consideration of the contractions of rank 2: the oriented matroid \mathcal{L}/n has the correct cocircuits (vertices).

Uniqueness of the extension follows from the fact that the graph of an affine pseudoarrangement (here: all the vertices and edges that lie on one side of the “new” pseudosphere S_n) is connected. This means that there is only a global choice of the “positive side” for the new pseudosphere S_n , but as soon as one vertex is chosen to be on the positive side, the others are determined. The connectedness result is a trivial special case of the fact that the whole complex of bounded faces (i.e., faces contained in the positive side of the new pseudosphere) is contractible [2, Thm. 4.5.7(ii)].

(2) The existence of the localization σ for any single element extension is elementary [2, Prop. 7.1.4(i)].

The formula for the ‘correct’ family \mathcal{L} realizing the extension corresponding to σ now follows by consideration of a topological realization. (This is the covector analogue of the — more complicated — formula for cocircuits given in [2, Prop. 7.1.4(ii)].) Topologically, the formula asserts that a cell lies on the positive hemisphere S_n^+ if and only if it contains a vertex in the positive hemisphere. This is because of the combinatorial fact that every covector is a conformal product of cocircuits, see [2, Prop. 3.7.2].

Thus we obtain that the extension can actually be constructed by embedding $\Delta(\mathcal{L}' \setminus \mathbf{0})$ into $\Delta(\mathcal{L} \setminus \mathbf{0})$. (See also [11, Sect. 2] for a related discussion, where this is asserted without a proof.)

(3) Finally, this follows from the Single Element Extension Theorem [2, Thm. 7.1.8, Fig. 7.1.6], which characterizes the ‘permissible’ localizations explicitly. Here we know from (1) that the distribution of zeroes and non-zeroes according to (ii) is permissible; condition (iii) shows σ is constant on the part of a pseudoline that is contained in an open hemisphere of S_n , and (i) shows that the two hemispheres get opposite signs. \square

Lemma 4.2 (Projection & Shrinking). *Let \mathcal{Z} be a WZT of a zonotope Z , and let $\mathcal{O} = \{\sigma(U) : U \in \mathcal{Z}\}$ be the set of sign vectors that makes it into a SZT according to Theorem 3.3.*

Shrinking. *The shrinking of the n -th zone,*

$$\begin{aligned} \mathcal{Z} \setminus n \quad := \quad & \{U - \mathbf{v}_n : \sigma(U)_n = +\} \cup \\ & \{U + \mathbf{v}_n : \sigma(U)_n = -\} \cup \\ & \{(U + \mathbf{v}_n) \cap (U - \mathbf{v}_n) : \sigma(U)_n = 0\} \end{aligned}$$

is a weak zonotopal tiling of $(Z + \mathbf{v}_n) \cap (Z - \mathbf{v}_n)$, with labels $\mathcal{O}' = \{X : (X, \sigma) \in \mathcal{O} \text{ for some } \sigma \in \{+, -, 0\}\}$.

Projection. *The projection of the n -th zone,*

$$\mathcal{Z} / n \quad := \quad \{\pi_n(U) : U \in \mathcal{Z}_n\}$$

is a weak zonotopal tiling of $\pi_n(Z)$, with labels $\mathcal{O}'' = \{X : (X, 0) \in \mathcal{O}\}$.

Proof. In other words, the shrinking of the n -th zone is geometrically realized by moving up all the zonotopes below the zone, and down all the zonotopes above the zone, each by half the length of the zone.

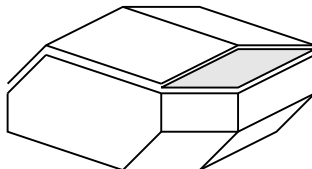

This ‘shrinking’ of the n -th zone realizes the affine oriented matroid $\mathcal{O}(\mathcal{L}')$ corresponding to \mathcal{L}' .

Similarly, the “projection” of the n -th zone parallel to the corresponding line segment realizes the affine oriented matroid $\mathcal{O}(\mathcal{L}'')$ associated with \mathcal{L}'' .

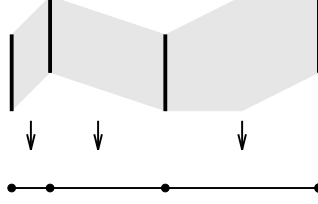

All the necessary information to verify our geometric intuition for these constructions is contained in Section Lemma 3.2. \square

Theorem 4.3 [3, Thm. 4.1]. *Let $V \in \mathbb{R}^{d \times n}$ be a configuration of vectors of rank $r - 1 \leq d$, let $Z(V)$ be the zonotope of dimension $\dim(Z(V)) = r$ it spans, and let $\mathcal{O} \subseteq \{+, -, 0\}^{[n]}$ be a strong zonotopal tiling of $Z(V)$. Then*

$$\begin{aligned} \mathcal{L}(\mathcal{O}) &:= \{(X, +) : X \in \mathcal{O}\} \cup \{(-X, -) : X \in \mathcal{O}\} \\ &\cup \{(X, 0) : X \in \mathcal{L}(V)\} \subseteq \{+, -, 0\}^{[n] \cup g} \quad (*) \end{aligned}$$

is an oriented matroid of rank r , which is a lifting of

$$\mathcal{L}(\mathcal{O})/g = \mathcal{L}(V).$$

Proof. Let $\mathcal{K} := \mathcal{L}(\mathcal{O}) \subseteq \{+, -, 0\}^{[n] \cup g}$ be the family of sign vectors defined by (*), and derive from it two new families, $\mathcal{L}' := \mathcal{K} \setminus n$ and $\mathcal{L}'' := \mathcal{K}/n$. These two families $\mathcal{L}', \mathcal{L}'' \subseteq \{+, -, 0\}^{[n-1] \cup g}$ satisfy $\mathcal{L}'' \subseteq \mathcal{L}'$ by construction, and they are easily verified to arise as $\mathcal{L}' = \mathcal{L}(\mathcal{O}')$ resp. $\mathcal{L}'' = \mathcal{L}(\mathcal{O}'')$, from the shrinking and the projection of the n -th zone, where

$$\mathcal{O}' = \{X : (X, \sigma) \in \mathcal{O} \text{ for some } \sigma \in \{+, -, 0\}\}$$

and

$$\mathcal{O}'' = \{X : (X, 0) \in \mathcal{O}\}$$

according to Lemma 4.2.

By induction on n we get that \mathcal{L}' and \mathcal{L}'' are oriented matroids of ranks $r - 1$ and r , respectively, so we are in the situation of Theorem 4.1. (The case where \mathcal{L}' has rank $r - 1$, and $\mathcal{L}' = \mathcal{L}''$, is trivial.)

Theorem 4.1(1) states the existence of an oriented matroid $\mathcal{L} \subseteq \{+, -, 0\}^{[n] \cup g}$ of rank r whose deletion is $\mathcal{L} \setminus n = \mathcal{L}'$, and whose contraction is $\mathcal{L}/n = \mathcal{L}''$, and we now will verify that $\mathcal{L} = \mathcal{K}$ (up to reorientation of the element n).

Define a function $\sigma : \mathcal{C}^*(\mathcal{L}') \rightarrow \{+, -, 0\}$ by the condition

$$(X, \sigma(X)) \in \mathcal{K} \text{ for all } X \in \mathcal{C}^*(\mathcal{L}').$$

This function is well-defined since every facet of the SZT \mathcal{O}' arises from a unique facet of \mathcal{O} , and similarly every facet of $Z \setminus n$ comes from a unique facet of Z .

Geometrically, $\sigma(X)$ indicates whether the corresponding full-dimensional tile Z_X of the shrinking $Z \setminus n$ lies “below the zone Z_n ” ($\sigma(X) = -$), “above the zone” ($\sigma(X) = +$) or “in the zone” ($\sigma(X) = 0$). Similarly, it classifies the $(d - 1)$ -dimensional facets of the “shrunk” zonotope $Z(V \setminus n)$: they get positive sign if they come from facets of Z above the zone, negative sign if they were below the zone, etc.

Now we verify that this localization function σ satisfies the characterization of Theorem 4.1(3). By construction we find that the conditions (i) and (ii) are satisfied. For (iii), we consider two adjacent cocircuits X^1, X^2 of \mathcal{L}' . Since they are adjacent, we may assume — by (i) — that their g -components are $+$ or 0 . Thus they correspond to tiles of $\mathcal{Z}\setminus n$ or to facets of $Z(V\setminus n)$.

Now we reverse the shrinking, and consider the tiles or facets which correspond to X^1 and to X^2 in \mathcal{Z} . They are still adjacent, unless they are separated by a face $Z_{(X,0)}$ in the zone. Then in the shrunk tiling we have that the intersection of Z_{X^1} and Z_{X^2} is the tile Z_X with $X = X^1 \circ X^2$, such that $X \in \mathcal{C}^*(\mathcal{L}'')$. Our drawing represents this situation in the case where $X_g^1 = 0$ corresponds to a facet of $Z(V\setminus n)$, but $X_g^2 = +$ corresponds to a tile in $\mathcal{Z}\setminus n$. Here X^1 gets the sign $\sigma(X^1) = +$, but $\sigma(X^2) = -$.

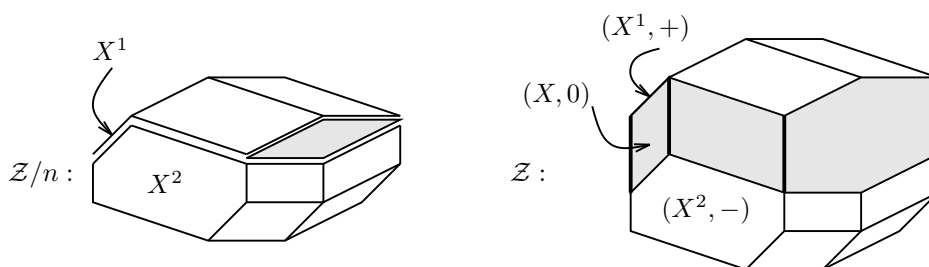

But adjacent tiles and facets that are not in the zone \mathcal{Z}_n have the same σ -sign. This implies (iii), and thus σ defines a single element extension \mathcal{L} of \mathcal{L}' whose contraction is \mathcal{L}'' .

Now we use the formula for \mathcal{L} from Theorem 4.1(2) to see that the extension \mathcal{L} coincides with the family of sign vectors $\mathcal{K} = \mathcal{L}(\mathcal{O})$ proposed by Theorem 4.3.

Finally, the fact that \mathcal{L} is a lifting of $\mathcal{L}(\mathcal{O})/g = \mathcal{L}(V)$ is clear by construction. The claim that \mathcal{O} determines $\mathcal{L}(\mathcal{O})$ is well-known (“the affine oriented matroid determines the oriented matroid”), see [2, p. 420]. \square

5. Oriented matroids not representable by tilings. We call an oriented matroid \mathcal{L} *representable by a zonotopal tiling* if there is a one-element extension $\mathcal{L} \cup f$ of \mathcal{L} such that the contraction $(\mathcal{L} \cup f)/f = \mathcal{L}(V)$ is realizable. In this case we can consider $\mathcal{L} \cup f$ as a lifting of the (realizable) oriented matroid $(\mathcal{L} \cup f)/f$ and the Bohne-Dress-Theorem gives us a zonotopal tiling of the zonotope $Z(V)$ that encodes the combinatorial content of $\mathcal{L} \cup f$ (and hence of \mathcal{L}).

Notice that all rank 3 oriented matroids are representable by a zonotopal tiling, since the contractions of rank 2 are always realizable. A natural questions that arises is whether all oriented matroids are representable this way. The answer is “no”. There are various constructions possible, based on *glueing techniques* developed by Richter-Gebert [12] [13].

As a specific counterexample we will here sketch the construction of a suitable oriented matroid. (With more effort in the construction also examples with less elements can be created. By suitable perturbation techniques it is furthermore possible to obtain uniform oriented matroids with the desired properties.)

Theorem 5.1. *There is a rank 4 oriented matroid on 40 elements that is not representable by a zonotopal tiling.*

Proof. We construct an oriented matroid \mathcal{L}' such that for every one-element extension $\mathcal{L}' \cup f$ the contraction $(\mathcal{L}' \cup f)/f$ is non-realizable.

Consider the three matrices P , S and Q given below. The row vectors of P are the homogeneous coordinates of the rank 3 line arrangement shown in the picture. This arrangement (call it $\mathcal{L}_P := \mathcal{L}(P)$) represents a realization of Pappos' configuration. Notice that if we perturb the coincidence of lines P_1, P_5 and P_9 , the corresponding pseudoline arrangement (call it \mathcal{L}'_P) is — by Pappos' Theorem — no longer realizable.

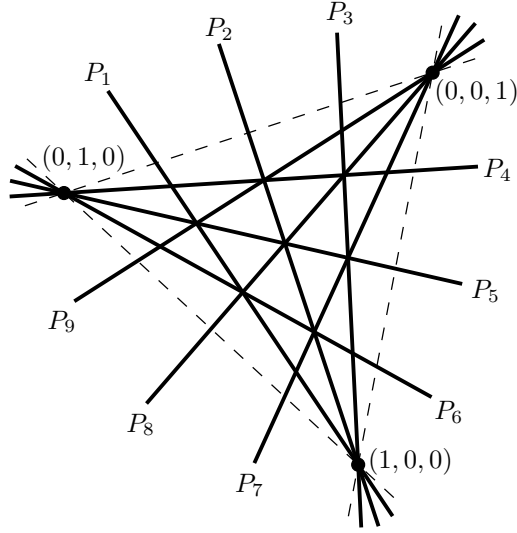

$$P = \begin{pmatrix} 0 & -2 & 1 \\ 0 & -1 & 1 \\ 0 & -1 & 2 \\ 1 & 0 & -2 \\ 1 & 0 & -1 \\ 2 & 0 & -1 \\ -2 & 1 & 0 \\ -1 & 1 & 0 \\ -1 & 2 & 0 \end{pmatrix} \quad S = \begin{pmatrix} 0 & 1 & 0 & 0 \\ 0 & 0 & 10 & 0 \\ 0 & 0 & 0 & 1000 \end{pmatrix} \quad Q = \begin{pmatrix} 0 & 1 & 0 & 0 \\ 0 & 0 & 1 & 0 \\ 0 & 0 & 0 & 1 \\ 1 & 0 & 0 & 0 \end{pmatrix}$$

Our aim is to construct a (non-realizable) rank 4 oriented matroid \mathcal{L}' with the property that every extension $\mathcal{L}' \cup f$ contains at least one copy of \mathcal{L}'_P in the contraction at f . Therefore we will first construct a (realizable) arrangement \mathcal{L} such that every extension contains \mathcal{L}_P at the contraction at the extended element. The pseudo hyperplane arrangement \mathcal{L}' is then obtained by a perturbation of \mathcal{L} .

Consider the hyperplane arrangement given by the row vectors of the matrices

$$A_i := P \cdot S \cdot Q^{i-1}$$

for $i = 1, \dots, 4$, together with hyperplanes specified by the four unit vectors e_1, \dots, e_4 . These 40 vectors form the homogeneous coordinates of our arrangement $\mathcal{L} := \mathcal{L}(A_1, \dots, A_4, e_1, \dots, e_4)$. Up to a relabeling of vertices the arrangements

$\mathcal{L}(A_i)$ and \mathcal{L}_P are isomorphic. Let v_i be the cocircuit corresponding to the intersection of the hyperplanes $\{e_1, \dots, e_4\} \setminus e_i$. Notice that for $i = 1, \dots, 4$ all the hyperplanes in A_i are incident with the cocircuit v_i . Therefore, if for an extension $\mathcal{L} \cup f$ the (pseudo-) hyperplane f does not meet the vertex v_i , then the contraction $(\mathcal{L} \cup f)/f$ contains the arrangement $\mathcal{L}(A_i)$ as a substructure. On the other hand any extension f cannot simultaneously be incident with all vertices v_1, \dots, v_4 , since the existence of such an extension would be incompatible with e_1, \dots, e_4 being non-degenerate. Taking together these two arguments we see that for every extension $\mathcal{L} \cup f$ the contraction $(\mathcal{L} \cup f)/f$ contains \mathcal{L}_P as a substructure.

Now we will describe the desired perturbation of \mathcal{L} . Notice that for $i = 1, \dots, 4$ the planes corresponding to $A_{i,1}, A_{i,5}, A_{i,9}$ intersect in a line l_i . The arrangement \mathcal{L} was chosen such that all cocircuits lying on l_i except of v_i are incident to exactly four hyperplanes (this was done by choosing the parameters in our matrix S in a suitable way). Therefore we can consistently perturb our arrangement in a way such that the planes $A_{i,1}, A_{i,5}, A_{i,9}$ become pseudohyperplanes just meeting in v_i and being in general position elsewhere. If we do this simultaneously for all $i = 1, \dots, 4$, we obtain the desired arrangement \mathcal{L}' .

The arrangement \mathcal{L}' has no extension by a pseudoplane that contains all four vertices v_i . Thus every extension of \mathcal{L}' now contains a copy of at least one perturbed pappos configuration \mathcal{L}'_P in its contraction. Therefore this contraction is not realizable. \square

6. Remarks. (1) To study the combinatorics of infinite zonotopal tilings (e.g., tilings of the whole euclidean plane \mathbb{R}^2), one partially needs different terminology and tools. We refer to Bohne [3, Chapter 6] for a development of *multiple oriented matroids* to this end.

(2) It is an unsolved problem to provide any kind of representation of general oriented matroids by a polytopal (zonotopal) complex. For example, Theorem 4.3 proves that in the case where \mathcal{L}/g is a realizable oriented matroid of rank d , the d -dimensional simplicial complex $\Delta(\mathcal{L}^+)$ considered in [2, Sect. 4.5] can be represented by the barycentric subdivision of a zonotopal tiling, and thus as a simplicial complex embedded into \mathbb{R}^d . In view of Theorem 5.1 it is not even clear that such a representation of an affine oriented matroid — by straight simplices in \mathbb{R}^d — exists in the general case.

(3) In conclusion, we want to show how the close connection between zonotopes and oriented matroids, as established by the Bohne-Dress Theorem, can be used to translate results between the two areas.

In one direction, questions about the combinatorics of an (affine) pseudoarrangement translate to corresponding questions about the dual cell complex, which is realized by the corresponding zonotopal tiling.

For example, a theorem of Shannon [15] [2, Thm. 2.1.5] states that for every straight projective arrangement of n hyperplanes of rank d , every hyperplane has at least d (full-dimensional) simplicial regions adjacent to it, and at least $n - d$ simplicial regions not adjacent to it. In particular there are at least n simplicial regions in total. Simplicial regions in pseudoarrangements correspond to *simple* vertices in the zonotopal tiling: vertices of degree d that are vertices of Z , or vertices of degree $d + 1$ that are not vertices of Z . (For example, the tiling in Section 0, with $d = 2$, altogether has 16 simple vertices: 8 vertices of degree 3 in

the interior of the zonotope, two vertices of degree 3 on the boundary which are not vertices of the original zonotope, plus 6 vertices of degree 2 on the boundary.) Thus we get the following.

- Every d -dimensional zonotopal tiling with n zones and realizable oriented matroid has at least n simple vertices. Moreover, there are at least d simple vertices on the boundary.

The analogous result is no longer true for the non-realizable case, see Richter-Gebert [12]. For example, there is an oriented matroid $R(20)$ of rank 4 on 20 elements such that the element 8 is not contained in a mutation, and $R(20)/8$ is realizable [12, Theorem 2.3]. This translates — via the Bohne-Dress Theorem — to the following.

- There is a zonotopal tiling of a 3-dimensional zonotope with 19 zones which that does not have a simple vertex on the boundary.

Similarly, a special case of Las Vergnas' conjecture [10] [2, Conj. 7.3.10] for oriented matroids translates to the conjecture that every zonotopal tiling has at least one simple vertex. This would be interesting to know even in 3-space.

On the other hand there are results and questions about zonotopal tilings and subdivisions of zonotopes which can profitably be translated to an oriented matroid setting, via the Bohne-Dress Theorem. For example, a special case of the “Generalized Baues Conjecture” of Billera, Kapranov & Sturmfels [1] states that the space of all zonotopal tilings of a given zonotope, and should have the homotopy type of a sphere. It was shown by Sturmfels & Ziegler [17] that — via the Bohne-Dress Theorem — this is equivalent to the following

- Conjecture: the simplicial realization of the poset of all single element liftings of a *realizable* oriented matroid has the homotopy type of a sphere.

In the dual formulation, as the “extension space conjecture” for realizable oriented matroids, this was studied in [17], using tools from oriented matroid theory. In general, for *non-realizable* oriented matroids, this fails:

- lifting spaces of non-realizable oriented matroids may have non-trivial homotopy types and can be even disconnected,

as shown by Mnëv & Richter-Gebert [13]. There is evidence, see [11], that the lifting space is substantially better behaved in the case of all liftings of a *realizable* oriented matroid, that is, in the case where the liftings can be represented by zonotopal tilings according to the Bohne-Dress-Theorem.

Acknowledgements. Thanks to Andreas Dress and to Horst Martini for helpful conversations and remarks.

REFERENCES

- [1] L. J. Billera, M. M. Kapranov & B. Sturmfels, *Cellular strings on polytopes*, Proc. Amer. Math. Soc., to appear.
- [2] A. Björner, M. Las Vergnas, B. Sturmfels, N. White & G. M. Ziegler, *Oriented Matroids*, Encyclopedia of Mathematics, Vol. 46, Cambridge University Press 1993.
- [3] J. Bohne, *Eine kombinatorische Analyse zonotopaler Raumaufteilungen*, Dissertation, Bielefeld 1992; Preprint 92-041, SFB 343, Universität Bielefeld 1992, 100 pages.
- [4] E. D. Bolker, *A class of convex bodies*, Trans. Amer. Math. Soc. **145** (1969), 323-345.
- [5] A. W. M. Dress, *Oriented matroids and Penrose-type tilings*, Lecture at the “Symposium on Combinatorics and Geometry”, organized by A. Björner, KTH Stockholm, August 1989.

- [6] J. Edmonds & A. Mandel, *Topology of oriented matroids*, Ph.D. Thesis of A. Mandel, University of Waterloo 1982, 333 pages.
- [7] J. Folkman & J. Lawrence, *Oriented matroids*, J. Combinatorial Theory, Ser. B **25** (1978), 199-236.
- [8] J. Karlander, *A characterization of affine sign vector systems*, European J. Comb., to appear.
- [9] M. Las Vergnas, *Extensions ponctuelles d'une géométrie combinatoire orientée*, in: Problèmes combinatoires et théorie des graphes (Actes Coll. Orsay 1976), Colloques internationaux No. 260, C.N.R.S. 1978, 265-270.
- [10] ———, *Convexity in oriented matroids*, J. Combinatorial Theory, Ser. B **29** (1980), 231-243.
- [11] N. E. Mnëv & G. M. Ziegler, *Combinatorial models for the finite-dimensional Grassmannians*, Special issue on "Oriented Matroids" (eds. J. Richter-Gebert, G. M. Ziegler), Discrete & Comput. Geometry **10** (1993), 241-250.
- [12] J. Richter-Gebert, *Oriented matroids with few mutations*, Special issue on "Oriented Matroids" (eds. J. Richter-Gebert, G. M. Ziegler), Discrete & Comput. Geometry **10** (1993), 251-269.
- [13] N. E. Mnëv & J. Richter-Gebert, *Two constructions of oriented matroids with disconnected extension space*, Special issue on "Oriented Matroids" (eds. J. Richter-Gebert, G. M. Ziegler), Discrete & Comput. Geometry **10** (1993), 271-285.
- [14] R. Schneider, *Über eine Integralgleichung in der Theorie der konvexen Körper*, Math. Nachrichten **44** (1970), 55-75.
- [15] R. W. Shannon, *Simplicial cells in arrangements of hyperplanes*, Geometriae Dedicata **8** (1979), 179-187.
- [16] G. C. Shephard, *Combinatorial properties of associated zonotopes*, Canadian J. Math. **26** (1974), 302-321.
- [17] B. Sturmfels & G. M. Ziegler, *Extension spaces of oriented matroids*, Discrete & Comput. Geometry **10** (1993), 23-45.
- [18] G. M. Ziegler, *Lectures on Polytopes*, Graduate Texts in Mathematics, Springer-Verlag New York 1994, to appear.

KONRAD-ZUSE-ZENTRUM FÜR INFORMATIONSTECHNIK BERLIN (ZIB), HEILBRONNER STR. 10,
10711 BERLIN, GERMANY

E-mail address: richter@zib-berlin.de and ziegler@zib-berlin.de